

VETERAN

VTR Series

Units with the LXG-300 Control Instrument



TEMPTEK, INC.

525 East Stop 18 Road Greenwood, IN 46142

317-887-6352 fax: 317-881-1277

Service Department fax: 317-885-8683

www.TempTek.com

E-mail: sales@TempTek.com

Model: _____

Serial Number : _____

VETERAN

VTR Series

INSTRUCTION MANUAL Veteran VTR Series with LXG-300 Control Instrument

COVERING

INSTALLATION OPERATION MAINTENANCE



TEMPTEK, INC. 525 East Stop 18 Road Greenwood, IN 46143
Phone: 317-887-6352 Fax: 317-881-1277 Service Department fax: 317-885-8683
www.TempTek.com E-mail: sales@TempTek.com

TABLE OF CONTENTS

1.0 GENERAL	9
1.1 Receiving Instructions	10
1.2 Introduction	10
1.3 Safety	10
1.4 Water Treatment	11
1.5 Components	11
2.0 INSTALLATION	13
2.1 General	14
2.2 To and From Process Connections	14
2.3 Water Supply Connection	15
2.4 Drain Connection	15
2.5 Electrical Connection	16
3.0 START UP SEQUENCE	19
3.1 General	20
3.2 Machine Start Up and Operation	20
3.3 Instrument : Quick Start	24
3.4 Instrument : Basic Navigation	26
3.5 Instrument : Operating Screens	27
3.6 Instrument : Fault Screens	28
3.7 Instrument : Main Menu	29
3.8 Instrument : Setpoints Menu	29
3.9 Instrument : Utilities Menu	31
3.10 Instrument : Network Menu	32
3.11 Instrument : Features menu	33
3.12 Instrument : Options Menu	36
3.13 Instrument : Machine Menu	37
3.14 Shut Down - Disconnect	38
4.0 TROUBLESHOOTING	39
4.1 Unit Will Not Start (Display is not Illuminated)	40
4.2 Unit Will Not Start (Display Illuminated)	40
4.3 Unit Stops	40
4.4 Unit Overheats	41
4.5 Unit Underheats	41
4.6 Pressure Relief Valve Leaks	42
5.0 MAINTENANCE	45
5.1 Pump Seal Replacement	46
5.2 Heater Replacement	49
5.3 Cooling Valve Service	50
5.4 Voltage Changeover	52
5.5 Sensor Probe Service	55
5.6 Pressure Switch Service	56
5.7 Electronic Instrument Repair Policy And Procedure	57
5.8 Temperature Probe Calibration	58
5.9 Heater Contactor and Pump Motor Starter	60



6.0	COMPONENTS	61
6.1	Mechanical system	62
6.2	Electrical system	63
7.0	RELATED DRAWINGS	65
7.1	Physical : Cabinet Style for Units up to 16 kW Heaters and Pumps to 3 HP	66
7.2	Physical : Cabinet Style for Units up to 24 & 34 kW Heaters and Pumps to 3 HP	67
7.3	Physical : Cabinet Style for Units up to 5 & 7.5 HP Pumps	68
7.4	Regulator / Bypass Installation	69
7.5	Dual Zone Dolly	70
7.6	Stacking Rack	71
8.0	APPENDIX	73
8.1	Model Number & Suffix Coding	74
8.2	Interpretation of Process Pressure Gauges	75
8.3	Operation of Mold Purge	76
8.4	Remote and Autostart Feature Configuration	78
8.5	SPI Commands	80
8.6	Communication Cable	83
8.7	Optional Alarm Operation	84
8.8	Standard G English Factory Default Settings	85
8.9	Parts : #119 Pump	86



THIS PAGE INTENTIONALLY BLANK

1.0 GENERAL

- 1.1 Receiving Instructions
- 1.2 Introduction
- 1.3 Safety
- 1.4 Water Treatment
- 1.5 Components



1.1 RECEIVING INSTRUCTIONS

- A. Temperature control units are generally shipped skid mounted, boxed and wrapped in plastic prior to shipment.
- B. Unbox the unit before accepting delivery. Check for visible damage and document any evident damage on the delivery receipt or refuse the shipment. Shipping damage is the responsibility of the carrier.
- C. In order to expedite payment for damages, should they occur, follow proper procedures and keep detailed records. Take photographs of any suspected damage.

1.2 INTRODUCTION

- A. This manual covers temperature control units from 10 to 34 kW of heating capacity using the LXG-300 control instrument. The standard fluid operating temperature range for this temperature control unit is 32°F to 300°F for units. Consult the factory if you have questions about the operating range of your temperature control unit.
- B. The intent of this manual is to serve as a guide in the installation, operation and maintenance of your temperature control unit. Improper installation can lead to equipment damage and poor performance. Failure to follow the installation, operation and maintenance instructions may result in damage to the unit that is not covered under the limited warranty. This manual is for standard products. The information contained in this manual is intended to be general in nature. The information is typical only and may not represent the actual unit purchased.
- C. When calling for assistance from the Manufacturer's Service Department, it is important to know the model and serial number of the particular unit. The model number includes critical unit information which is helpful when troubleshooting operating difficulties. The serial number allows the service team to locate manufacturing and testing records which can have additional information relating to a particular unit.



WARNING: *This equipment contains hazardous voltages that can cause severe injury or death. Disconnect and lock out incoming power before installing or servicing the equipment.*

1.3 SAFETY

- A. It is important to become thoroughly familiar with this manual and the operating characteristics of the unit.
- B. It is the owner's responsibility to assure proper operator training, installation, operation, and maintenance of the unit.
- C. Observe all warning and safety placards applied to the unit. Failure to observe all warnings can result in serious injury or death to the operator and severe mechanical damage to the unit.

- D. Observe all safety precautions during installation, startup and service of this equipment due to the presence of high voltage. Only qualified personnel should install, startup and service this equipment.
- E. When working on this equipment, observe precautions in literature and on tags, stickers and labels located on the equipment. Wear work gloves and safety glasses.
- F. Before installing and operating the unit, be aware of and follow any local laws and codes that apply to the installation.
- G. Samples of Warning Labels applied to typical temperature control units.
 - 1. Alerts users to the danger of high voltage.



- 2. Alerts the user to possible explosive danger.



- 3. Alerts the user to a hot surface danger due to high operating temperatures.





WARNING: Improper water treatment will void unit warranty.

1.4 WATER TREATMENT

- A. The fluid used in your temperature control unit will greatly effect its short and long-term operation. Lack of as well as improper water treatment can damage the temperature control unit by causing scale build-up, excessive corrosion and/or bacterial contamination. It is the equipment owner's responsibility to prevent damage caused by poor water quality. The services of a water treatment professional is recommended.
- B. The use of untreated or improperly treated water in a temperature control unit may result in scaling, erosion, corrosion, algae, bacteria or slime. The manufacturer recommends filtering the process water to prevent solids from plugging critical parts.
- C. It is recommended that the services of a qualified water treatment specialist be engaged to determine what water treatment is required.
- D. The Manufacturer assumes no responsibility for equipment failures which result from untreated or improperly treated water.
- E. Do not use deionized water in this unit. Some customized units may be compatible with deionized water. Consult the factory before using deionized water.

1.5 COMPONENTS

Cabinet style for units with:
• 24 & 34 kW heaters
• Up to 3 hp pumps
Approximate dimensions:
44" h x 16" w x 24" d

Cabinet style for units with:
• 5 & 7½ hp pumps

Cabinet style for units with:
• 16 kW & smaller heaters
• 3 hp & smaller pumps
Approximate dimensions:
29 ½" h x 12 ½" w x 19" d



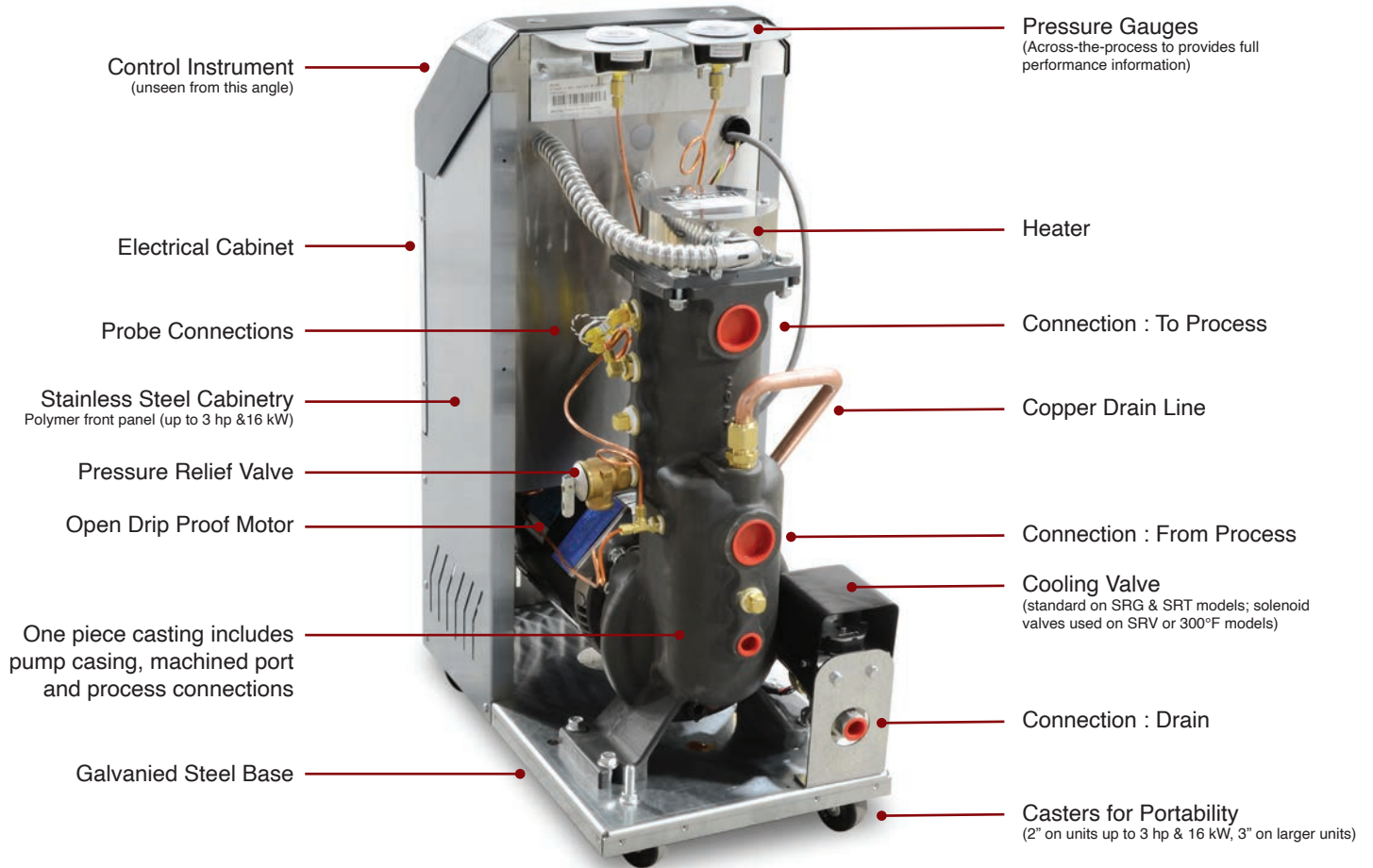

THIS PAGE INTENTIONALLY BLANK

2.0 INSTALLATION

- 2.1** General
- 2.2** To and From Process Connections
- 2.3** Water Supply Connection
- 2.4** Drain Connection
- 2.5** Electrical Connection



2.1 GENERAL

- A. Care should be taken to use materials (hose, rigid piping, valves or filters) rated for the temperature and pressure duty of your unit. Most units have a maximum operating temperature of 300°F or less and a maximum pressure of 150 PSI. The unit is most efficient when full size plumbing is run from the unit connections to and from the process. If necessary, reduce the plumbing size at your process, not at the unit.
- B. Be certain all process piping materials have the equivalent or larger diameter of the particular process connection.

*Connect Unit water supply to plant's city water or well water source or tower water supply or chilled water supply.

**Connect Unit drain to plant's open drain or tower water system return or chilled water system return.

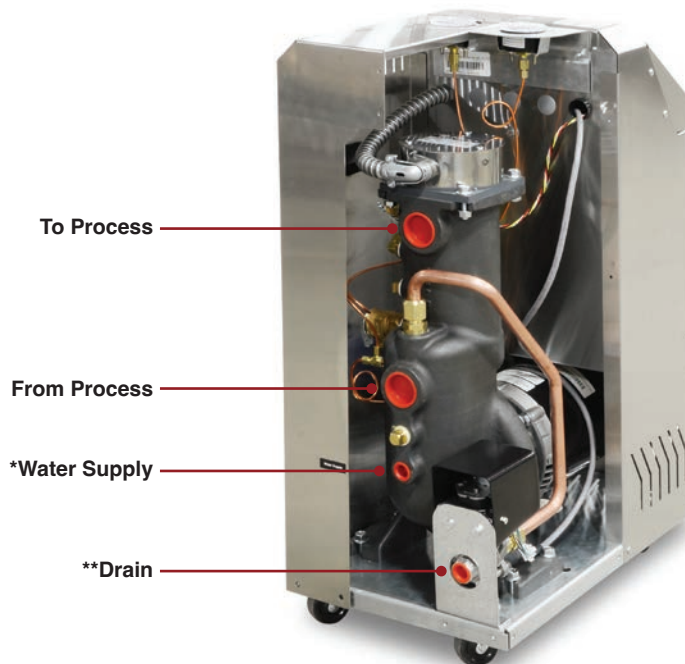

2.2 TO AND FROM PROCESS CONNECTIONS

- A. Connect the unit's *To Process* port to the *Water In* port on the process manifold.
- B. Connect the unit's *From Process* port to the *Water Out* port on the process manifold.
- C. **Please note:** Process water piping circuitry should be designed to avoid an excessive use of elbows and/or lengths of pipe or hose. If hose is the material of choice, avoid tight twists or curls and excessive lengths.
- D. Valves and filters may be installed in the process water piping circuitry to facilitate service and maintenance, provided that such devices maintain the full inside diameter of the process connection. If installed, all such devices must be open and clean during unit operation.



WARNING: Check local codes to determine proper use of back flow prevention device in water supply line.

2.3 WATER SUPPLY CONNECTION

- A. Connect the unit's *Water Supply* port to the plant's city water, well water, tower water or chilled water supply.
- B. The factory recommended minimum operating water supply pressure requirement is **60 PSI**. The required water supply pressure retains process water in a liquid state at temperatures over 180°F. Failure to maintain the required water supply pressure will cause premature failure of and increase maintenance in susceptible areas such as the shaft seal and heater.
- C. Static water supply pressure can be determined at the unit's location by reading the unit's 0-160 PSI pressure gauges when the unit's pump motor is **OFF**.
- D. If water supply pressure as read on the unit's pressure gauges exceeds 75 PSI, a **pressure reducing valve** must be installed in the water supply line (refer to section 7.3 of this manual for installation information). The factory recommended 'regulated pressure out' is 60 PSI.

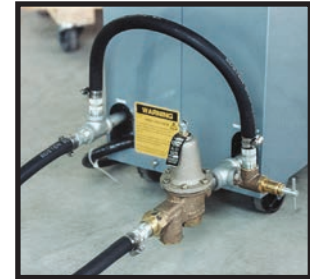

Typical pressure reducing valve installation (shown on S-925 model).

2.4 DRAIN CONNECTION:

- A. Connect the unit's **DRAIN** port to one of the following, determined by the water supply source:
 - 1. Open drain for well or city water supply.
 - 2. Tower water system return for tower system water supply.
 - 3. Chilled water system return for chilled water system supply.
- B. The factory recommends a minimum of 10 psi pressure differential between the water supply and drain line for proper cooling.
 - 1. The amount of cooling provided by the unit depends on:
 - a. The cooling valve size
 - b. The pressure differential across the valve
 - c. The temperature difference between the unit set point and the cooling water temperature
 - d. The cooling valve position
 - 2. Consult factory when selecting the correct cooling valve for your application.

3. In general the standard ½” cooling valve will provide approximately 24,000 Btu/hr (7 kW) of cooling per every 10°F difference between the cooling water temperature and the process set point based on 25 psi delta p across the cooling valve with ½” supply & return connections. Connecting the unit with ¾” or 1” cooling water supply and return connections will increase the cooling capacity of the unit.
- C. For most applications, the drain line should not be valved. However, for installations with a pressurized drain system, it may be necessary to install a valve in the drain line. In such cases, the installed valve must be fully opened after installation and the valve handle removed to prevent operating the unit with a closed drain valve. The valve handle can be reattached to the valve body when it is necessary to close the valve.
- D. **CAUTION:** The unit must never be operated with a closed drain line valve. A closed drain line valve prevents adequate system cooling and will lead to unit overheating. Overheating of the unit may lead to unit damage and/or serious personal injury.



WARNING: Never operation the Temperature Control Unit with a closed drain.

2.5 ELECTRICAL CONNECTION

A. Standard Models

1. Electrical power supply requirements for standard units are identified on the equipment data tag. Verify that available voltage supply is the same as the unit’s voltage requirements.

WARNING: DO NOT CONNECT THE UNIT TO A VOLTAGE SUPPLY SOURCE NOT EQUAL TO THE UNIT’S VOLTAGE REQUIREMENTS AS SPECIFIED ON THE UNIT’S DATA PLATE.

Use of incorrect voltage will void the unit’s warranty and cause a significant hazard that may result in serious personal injury and/or unit damage.

2. For standard units with 10 and 16 KW heaters and up to 3 horsepower pumps, a four conductor cable, 10 foot in length, is provided for connection to an operator supplied fused disconnect.
3. For units with 24 and 34 KW heaters, the operator must provide a four conductor power cable and the fused disconnect.
4. The owner supplied fused disconnect must be sized and installed according to the unit’s power supply requirements and local electrical codes.

B. Models With Factory Included Disconnect Switch and Other Custom Features

1. Some units may be customized and include a factory supplied power disconnect switch and/or higher specification electrical enclosure. Electrical power supply



WARNING: Do not connect the unit to a voltage supply not equal to the unit's voltage requirements as specified on the unit's data plate. Use of incorrect voltage will void the unit's warranty and cause a significant hazard that may result in serious personal injury and unit damage.



WARNING: Electric Shock Hazard. High Voltage is present in the electrical cabinet. Disconnect power before servicing. Follow all facility lock-out tag-out procedures.

requirements are identified on the equipment data tag. Verify that available voltage supply is the same as the unit's voltage requirements.

WARNING: DO NOT connect the unit to a voltage supply source not equal to the unit's voltage requirements as specified on the unit's data plate. Use of incorrect voltage will void the unit's warranty and cause a significant hazard that may result in damage to the unit or serious personal injury.

2. Appropriate conduit and fittings should be selected which will maintain the integrity of the cabinet.
3. Supply a power conductor sized according to the unit's power supply requirements. Connect the power conductor to the unit's power supply entry terminal block.

C. Control Circuit Wiring

1. The unit's supplied control circuit is 110 volt, 1 phase, 60 cycle. The control circuit is supplied by the factory installed transformer. A control circuit fuse is provided.

D. General

1. Make certain all ground connections to the unit are properly affixed. A proper connection to earth ground is required. A conduit ground is not a reliable conductor!
2. Make certain the power conductor, disconnecting means, and fusing are properly sized according to the unit's power supply requirements.
3. Make certain all electrical connections are tightly affixed. Any loose wiring connections must be tighten before engaging the power supply.
4. Make certain no moisture or standing water is present inside the electrical cabinet.

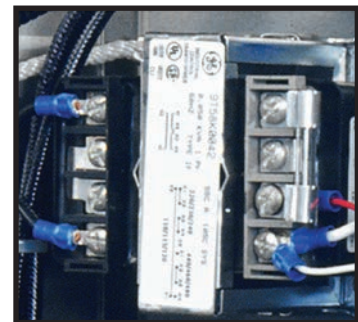

Control circuit transformer fuse



WARNING: Check that all electrical connections are tight before starting.
Disconnect power before servicing. Follow all facility lock-out tag-out procedures.

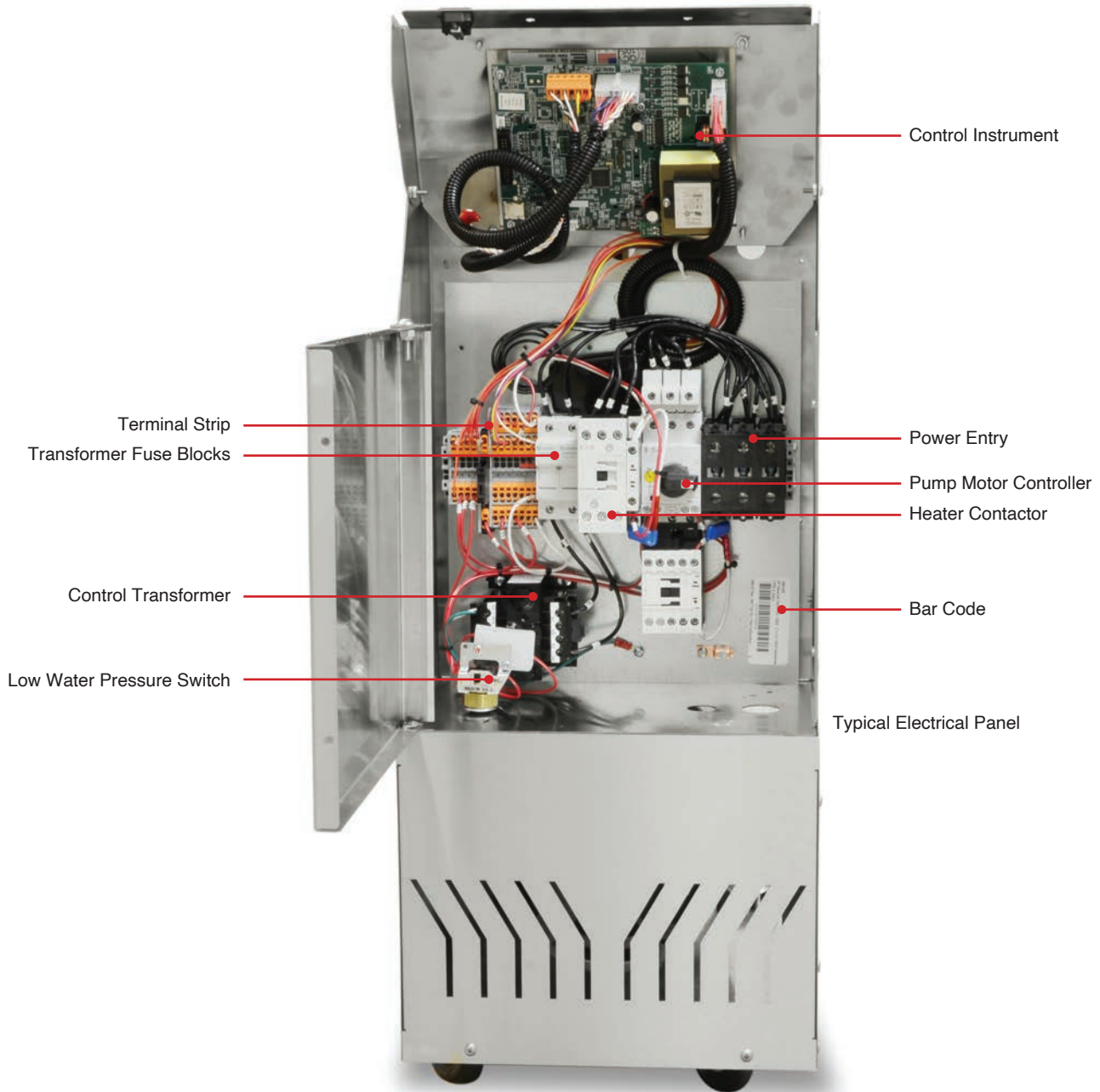

Control Instrument

Terminal Strip
Transformer Fuse Blocks

Power Entry

Pump Motor Controller

Heater Contactor

Control Transformer

Bar Code

Low Water Pressure Switch

Typical Electrical Panel

3.0 OPERATIONS

- 3.1** General
- 3.2** Machine Start Up and Operation
- 3.3** Instrument Operation : Quick Start
- 3.4** Instrument : Basic Navigation
- 3.5** Instrument : Operating Screens
- 3.6** Instrument : Fault Screens
- 3.7** Instrument : Main Menu
- 3.8** Instrument : Setpoints Menu
- 3.9** Instrument : Utilities Menu
- 3.10** Instrument : Network Menu
- 3.11** Instrument : Features Menu
- 3.12** Instrument : Flow Menu (option)
- 3.13** Instrument : Options Menu
- 3.14** Instrument : Machine Menu
- 3.15** Shut Down / Disconnect



3.1 GENERAL

- A. Failure to follow the factory required operation procedures may adversely affect the unit's ability to adequately control process temperature and may create a hazardous operating condition which may result in unit damage or serious operator injury.
- B. The Operations segment of this manual is outlined below:



WARNING: Follow all Factory operations procedures. Failure to do so may create a hazardous operating condition which may result in serious operator injury and/or unit damage.

- 3.2 **Machine start-up/operations procedure** - follow this segment to start the unit after the initial installation or to restart the unit after reinstallation to the same or different process. This section includes information on system fill, electric motor phasing (pump rotation) and process flow adjustments.
- 3.3 **Instrument Operation** - follow this segment to start up and operate the instrument. This section includes information on automatic and manual venting, setpoint selection and adjustment, and feature explanations.
- 3.4 **Shut down procedure** - follow this segment to shut down the unit. This segment includes information on system cool down, shut down, electrical power supply precautions, and disconnection from the system.

3.2 MACHINE START UP AND OPERATION

A. System Fill

- 1. Engage the water supply source by opening the water supply valve (customer installed) at the unit's location. If a valve is not installed, engage the water supply source at the plant's water supply central control point.
- 2. Once the water supply source is open, the unit will fill automatically. Allow a few moments for the unit to completely fill. The operator can determine the unit is properly filled when the *To Process* pressure gauge and the *From Process* pressure gauge stabilize at equal or closely similar pressure.
- 3. The operator must check for any water leakage in the unit's mechanical system, the process, and throughout the plant's water supply system. If a water leak is observed, the operator must disengage the water supply system, relieve all pressure, and repair the leak. The operator must verify the leak is repaired by refilling the system as outlined in this procedure.
- 4. During system fill, air is often trapped in the water system. Air is purged automatically via the AVT™ valve during initial pump start-up. All air must be purged before the unit is engaged for process temperature control. The automatic stat-up vent parameters are adjustable. See Section 3.5.F for more information.

Entrained air in the system will adversely affect the unit's ability to control process temperature and can cause heater failure when the heating elements are exposed to this air.



5. Adequate water fill and pressure must be supplied to the unit for efficient and safe operation. To ensure sufficient water fill, an electrical panel mounted pressure switch is supplied with the unit. A capillary line feeds the pressure switch. If the water supply pressure is not adequate the unit can not be operated. This prevents operation with inadequate water fill and pressure. If the unit is operated without adequate water fill and pressure, the unit may be susceptible to overheating and could result in unit damage and/or serious injury to operating personnel.

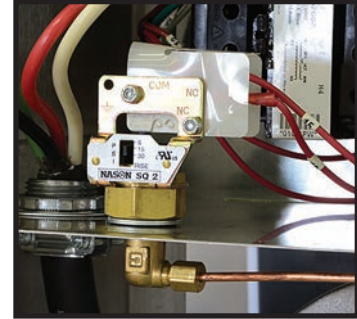

Panel mounted pressure switch

B. Electric Motor Phasing (Pump Rotation)

1. The operator must determine the electric motor is phased correctly. This is done by visually inspecting the rotation of the motor shaft as outlined below. Incorrect phasing of the unit results in poor operation and eventual damage.
 - a. Supply electrical power to the unit by engaging the unit's disconnect switch. Once the correct voltage is supplied to the unit, the *Power* light on the display will illuminate.
 - b. Remove the thermoformed cover panel and open the hinged electrical cabinet panel cover. **Note that the electrical power is engaged at this point and caution must be observed while the electrical supply is engaged and the cabinet panel is open.**



WARNING: *Electrical power is engaged and caution should be employed while the cabinet is open.*

- c. Locate the electric motor and identify the motor shaft inside the electric motor housing. The motor shaft can be seen through the vent slots in the motor housing or by removing the shaft cover.
 - d. Toggle the *On / Off* switch. This will cycle the motor “on” and then “off”.
 - e. Observe the motor shaft as it slows to a stop to identify the rotation. Correct rotation is “clockwise”, when viewed from the rear of the motor. Incorrect rotation is “counter-clockwise” when viewed from the rear of the motor. If the shaft does not rotate when the unit is started, the operator must identify the cause as outlined in this manual's troubleshooting and repair section.
 - f. If the unit is phased correctly, continue with the start up procedure at step C. If the unit is phased incorrect, continue with step 2.
2. To correct unit phase:
 - a. Disengage the electrical power supply to the unit at the unit's disconnect

switch. Follow proper lockout procedures before proceeding.

- b. Once the electrical power supply is disengaged, reverse any two power leads of the power cord at the fused disconnect terminals.
- c. **Note: The operator must reverse the power leads at the disconnect only and *not* at the power entry terminals on the unit's electrical panel.** The unit's internal electrical system wiring is phased correctly at the factory and must not be altered in the field.

- 3. To visually verify pump rotation, start the unit and observe the pressure gauges. The To Process pressure will indicate 35-50 PSI more than the From Process pressure. In this state, the pump rotation is correct (clockwise). If this is not evident the unit is not correctly phased and should be corrected as outlined in step 2.

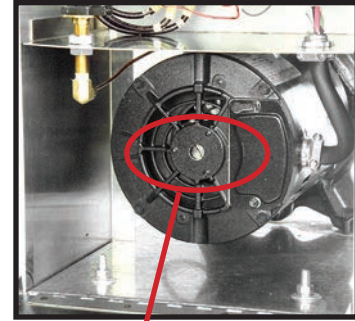

Remove shaft cover to view the motor shaft

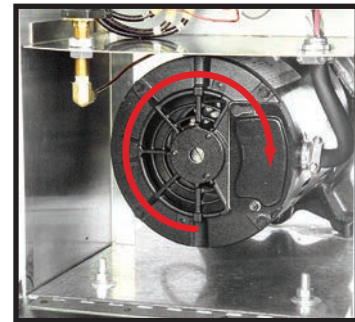

Correct rotation is clockwise when viewed from the rear of the motor.

C. Process Flow Adjustments

- 1. The operator must determine and set proper water flow rate for the most efficient and trouble free operation.
 - a. Water flow rate through the process is determined by the pressure losses in the process loop. Generally, higher flow rates result in turbulent flow achieving maximum temperature control and lower maintenance.
 - b. If the flow rate exceeds the motor HP capacity, the electric motor will draw excessive amps. This is a result of the process loop's ability to flow water at a greater rate than can be provided by the pump. This will eventually result in tripping the thermal motor overload relay (overload relays open) and the unit will shut down and illuminate the *Safety* and *Alarm* lights on the display.
- 2. If an excessive flow situation is encountered and the motor overload circuit has tripped, the operator must manually reset the overload relay before operations can continue. This is done by opening the electrical panel cover and identifying the overload relay.

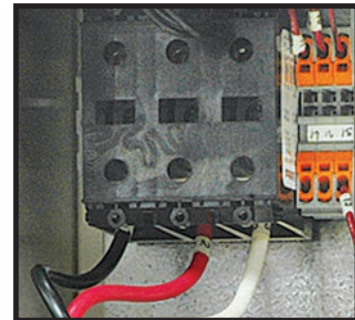

DO NOT reverse power leads at the unit's power entry



WARNING: To correct phase ... switch power leads at the disconnect switch only.

Some older models have overload relay where a red button that pops out if the overloads are tripped. Simply push the button in until the overloads are reset.

Other overload relays have a switch. This switch will be positioned with the indicator pointing up when in normal operation. The indicator will be pointing to the left when the overloads are tripped. To reset, simply turn the switch to where the indicator points up.



Normal Operating Position

Tripped Position

3. If a motor overload situation persists, the operator must adjust the flow rate to match the system pressure loss (reduce flow rate) to prevent continual tripping of the overload relay. This procedure is outlined here:
 - a. Open electrical cabinet panel door. The panel cover is hinged and held open by a support cable. **Note that the electrical power is engaged at this point and caution must be observed while the cabinet panel is open.**



WARNING: Electrical power is engaged and caution should be employed while the cabinet is open.

- b. Identify the motor starter block. This block consists of the motor starter contactor and the overload relay.
- c. Place an amp meter on a single power lead coming from the overload relay.
- d. Locate the motor name plate on the pump motor housing. The full load amp rating for the motor is listed on the name plate.
- e. Engage the electrical power supply and start the unit.
- f. The amp meter will display the motor amps. Compare the actual motor amps as displayed on the amp meter to the full load amp rating as listed on the motor name plate.
- g. If the amp draw is excessive (higher than the listed name plate amp rating), a throttling valve must be installed in the “from process” water

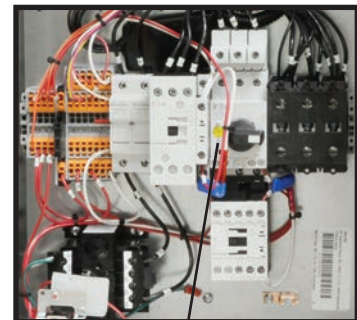

Pump Motor Controller

line. The throttling valve can be a gate valve or a ball valve.

- h. With the throttling valve installed, fully close the valve and then engage the pump motor. Slowly open the throttling valve and monitor the motor amps as displayed on the amp meter until the actual motor amps equal the listed full load amp rating of the motor. The process flow is now correctly adjusted. The valve should remain in this position during operation.



- 6. **LOW PROCESS FLOW:** The minimum recommended process flow rate is 10 GPM. Process restrictions may limit the flow to less than 10 GPM. We recommend the addition of bypass lines to raise the flow rate to 10 GPM. The best place to add bypass lines are on the extra ports on the molding machine manifold. If extra ports are not available, add a tee in the *To Process* and *From Process* lines, install a bypass line between the two tees with a throttling valve. Adjust the valve for a minimum of 10 GPM.

3.3 INSTRUMENT : QUICK START

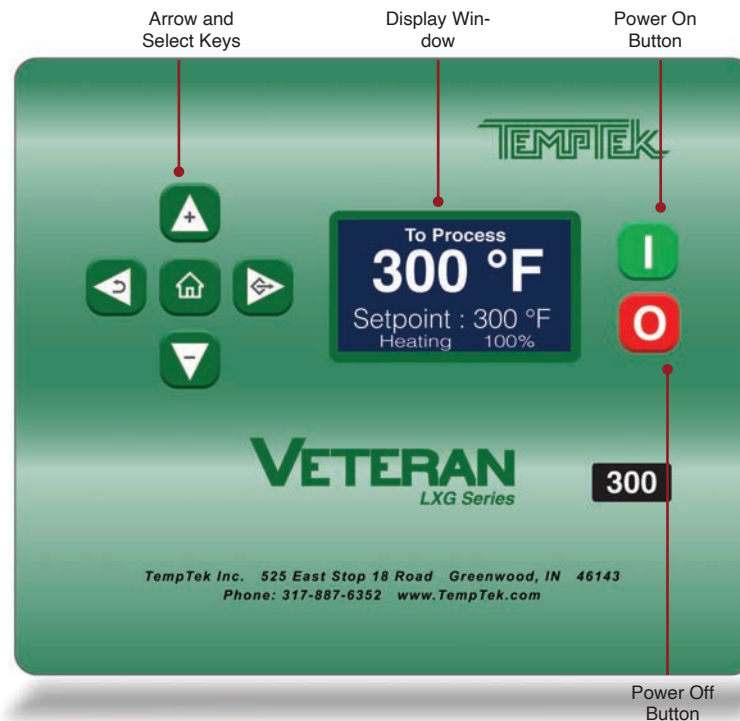

1. Apply power. The Standby screen will illuminate. When Standby is displayed on the screen, the unit is not running.

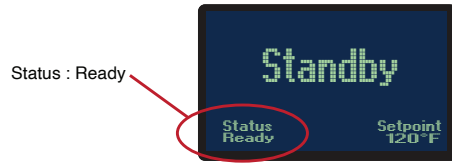

2. After applying power a screen that reads "Not Ready" typically indicates the presence of a sensor probe fault, pressure switch fault or motor overload fault. See the troubleshooting and maintenance portions of the manual for additional Information. **The fault must be corrected in order to continue operation of the unit.**

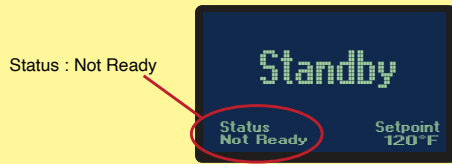

3. This unit features an LCD screen. Use the five soft touch buttons to navigate the available screens and select parameters.
4. A System Safety Fault may prevent startup. Probe, cooling valve, water supply pressure, pump overload or high temperature limit may display once power is applied and must be corrected prior to operation.
5. Adjust the setpoint to the desired value by pressing the Increment or Decrement buttons.

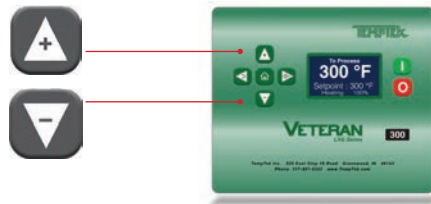

6. The unit is ready to start when no errors are shown on the screen. Press the green start button. The unit will auto vent if the fluid temperature is below 100°F or as programmed in the Features menu.



7. Once the autovent sequence is complete the unit will heat or cool to maintain the setpoint temperature.

3.4 INSTRUMENT : BASIC NAVIGATION

A. The instrument has 5 soft keyed buttons.

1. The Home button, when pressed , shows the Home screen.
2. The Up button, when pressed, will add one unit of value or will scroll up through a menu.
3. The Down button, when pressed, will subtract one unit of value or will scroll down through a menu.
4. The Go button, when pressed, will advanced through a series of screens or save a value.
5. The Back button, when pressed will go backwards through a series of screens.

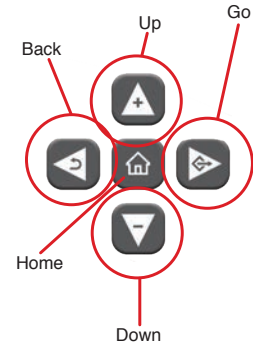

B. Prompts on Selection Screens. Selection screens display a menu of selectable items.

1. The Up button will scroll up through the menu items. The screen indicators will scroll along with the pressing of the button.
2. The Down button will scroll down through the menu items. The screen indicators will scroll along with the pressing of the button.
3. The Go button will advance to the value screen of the selected parameter.
4. The Back button will return to the previous screen. Successive pressing of the Back button will eventually end at the Home screen.

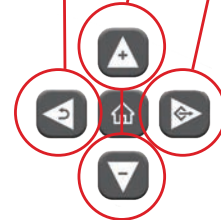
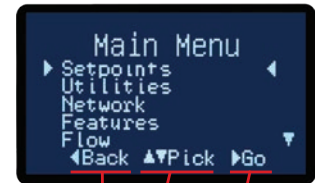

C. Prompts on Value Screens. Value screens allow the user to set or change parameter values.

1. The Up button will add to the value of the parameter.
2. The Down button will subtract value from the parameter.
3. The Go button will save the new value to memory.
4. The Back button will cancel the transaction and will return to the parent screen.

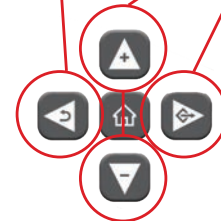

D. Prompts on Success Screens. Success screens appear once a value is changed and the new value is successfully saved. The screen shows the name of the parameter and

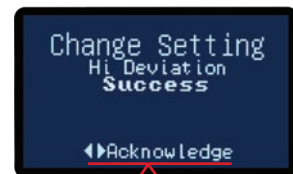

displays “Success” as indication the value was saved.

1. Use the Go or Back buttons to acknowledge the prompt.
2. After acknowledging the success, the screen returns to the parent screen.



Horizontal Indicators

Vertical Indicator

E. Screen Indicators.

1. Small indication triangles are used as on screen pointers.
2. The horizontal indicators point to the current selection. By pressing the Go button, the screen advances to that selection.
3. The vertical indicator shows that some menu items are not currently shown on the screen. By pressing the Down button, the menu will scroll down to display the menu items not currently visible. By pressing the Up button, the menu will scroll up.

3.5 INSTRUMENT : OPERATING SCREENS



- A. The instrument displays several operating screens to indicate what the unit is doing as far as heating, cooling and other functions. In most operating screens, the To Process temperature is shown with the operation indicated under the setpoint temperature, as shown in the examples below.
- B. **Auto Vent.** Auto vent occurs when the start button is pressed and the process temperature is below 100°F (factory default). Auto Vent purges air from the process on initial start with cooler temperatures. However, when the unit is started and the process temperature is above 100°F, the instrument assumes this is not an initial start up and the auto vent is bypassed. The temperature and time parameters of the Auto Vent are programmed in the Features Menu.
- B. **Heating.** The amount of heating applied to the process is indicated in the Heating Screen.
- C. **Cooling.** The amount of cooling applied to the process is indicated on the Cooling Screen. The amount of cooling is the aperture opening of the modulating cooling valve.
- D. **Pump Seal Cooling.** This screen appears when the unit is stopped. However, the pump will continue to run and the cooling valve will open 100% to reduce process temperature to a safe shutdown temperature. The time and temperature of the pump seal cooling feature are programmed in the Feature Menu.

3.6 INSTRUMENT : FAULT SCREENS

A. Faults Preventing Start Up or Operation :

1. System Safety. This fault screen appears if the following occurs:



- a. **Water Pressure.** The unit will not operate without adequate water supply pressure. Sufficient water supply pressure must be present to close the water pressure switch. Minimum water supply pressure is 55 PSI. Water supply pressure should not exceed 75 PSI. If water supply pressure exceeds 75 PSI, a pressure reducing valve must be installed in the water supply line. See Section 2.3 for additional information.
 - b. **Motor Overload.** The unit will not start or run if the motor overload is tripped. During operations, this error is triggered by excessive flow causing the pump to draw more amps than it is rated for. A throttling valve should be placed in the from process line to control flow.
2. **Cooling Valve.** Debris or other obstructions trapped in the valve orifice can cause this fault. If not, the valve could be defective and should be replaced.
 3. **High Temp.** If process temperature exceed 300°F, the high temperature limit switch opens and the unit shuts down. High temperature conditions are generally caused by inadequate water supply pressure, a defective cooling valve, an obstructed drain line or high back pressure in the drain. Determine the cause and correct. See the troubleshooting section of this manual for more information. The high temperature limit switch will automatically reset as the unit cools.

B. Faults Not Preventing Start Up or Operation :



1. **Phase.** This fault screen appears if the unit is incorrectly phased to the plant power. A phase issue is usually detected at first start up. The unit will operate if the green Power button is pressed. However, the unit's pump will operate backwards and there will be minimal flow to process.

To correct, follow all lock out tag out policies to shut down power to the unit at the disconnect. Reverse any two power wires at the disconnect to correct phase.

Do not reverse the unit's internal wiring to correct a phase condition.

3.7 INSTRUMENT : MAIN MENU

A. The Main Menu offers the ability to set and change values in the following areas:

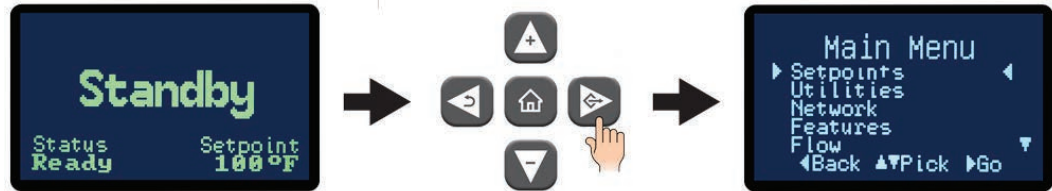

1. Setpoints.
2. Utilities.
3. Network.
4. Features.
5. Flow.
6. Machine.

B. The Main Menu is accessible from the Standby screen by pressing the Go button.

C. The Main Menu is also accessible from any Operating screen by pressing the Go button. In the example below, while on the Cooling screen, pressing the Select button will advance to the Main Menu.

3.8 INSTRUMENT : SETPOINTS MENU

A. Under the Setpoints menu item, the values for the Process Setpoint, Hi Deviation, Low Deviation and Low Flow can be set or changed. Digital flow rate display is an option and may not be included on your machine.



B. **Process Setpoint.** Use the Up or Down buttons to change the process setpoint.



1. The Setpoint range is from 32°F to 300°F. Please note, the unit can not reduce process temperature below the provided water supply temperature.
2. Once acknowledged, the unit will control to the new setpoint temperature. Press the Back button repeatedly to return to the Setpoints screen or press the home button to return to the Home screen.

- C. Hi Deviation.** The High Deviation value programs the controller to sound the alarm if the process temperature exceeds the set difference from setpoint. For example, Hi Deviation = 5°F, Setpoint = 200°F. Hi deviation alarm will sound if the temperature reaches 205°F.



1. The factory default is 10°. The range for the Hi Deviation is from 0°F - 50°F.
2. Once acknowledged, press the Back button repeatedly to return to the Setpoints screen or press the home button to return to the Home screen.

- D. Lo Deviation.** The Lo Deviation value programs the controller to sound the alarm if the process temperature exceeds the set difference from setpoint. For example, Lo Deviation = 5°F, Setpoint = 200°F. Lo deviation alarm will sound if the temperature cools to 195°F.



1. The factory default is 10°. The range for the Lo Deviation is from 0°F - 50°F.
2. Once acknowledged, press the Back button repeatedly to return to the Setpoints screen or press the home button to return to the Home screen.

- D. Low Flow (optional feature not included on all units).** The Low Flow value programs the controller to sound an alarm if the process flow goes below the low flow set value. For example, if the flow set value is 3 GPM and if the flow goes below 3 GPM an alarm condition is indicated. Note: the low flow alarm feature is only available with the purchase of the optional flow meter.



1. The factory default is 0 GPM. The range for the Low Flow is from 0 to 100 GPM.
2. Once acknowledged, press the Back button repeatedly to return to the Setpoints screen or press the home button to return to the Home screen.

3.9 INSTRUMENT : UTILITIES MENU

- A. Items in the Utilities menu include the operations for the Mold Purge, Manual Vent, Software Version Number and Display Test.
- B. **Mold Purge (optional feature not included on all units).** The mold or system purge system contains several solenoid valves and check valves. When activated and supplied with compressed air, the mold or system purge system will expel process water from the mold to the drain. Mold or system purge systems are supplied as a factory installed option or a field retrofitted kit.

1. On selecting the mold purge feature, the controller checks to determine if the pump is running. If it is, then the Unable To Mold Purge Message will be displayed.



2. When the pump is not running and when Mold Purge is enabled (refer to Section 3.13 for more information on enabling Mold Purge) Mold Purge is activated by selecting the mold purge item from the Utilities menu. Mold purge is started immediately. When mold purge is activated the following screen will show.



3. Press the back button or the stop button to stop the Mold Purge.

- C. **Manual Vent.** Manual venting is achieved by fully opening the cooling valve. To initiate a manual vent, advance to the Utilities screen and select the Manual Vent item.

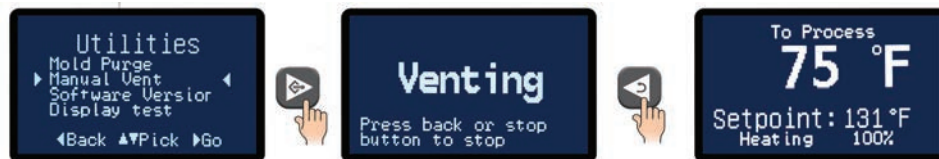

1. Press the Select button to start the venting.
2. To stop the venting, press the Back button. On release, the screen will return to the Home screen.

- D. **Software Version.** The software version number is the current version of the controller's software. This number can be useful when troubleshooting at times.

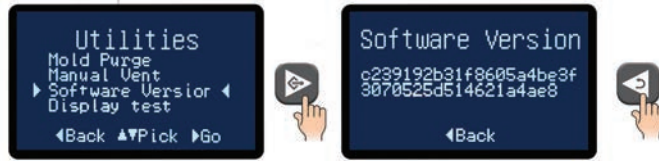

1. Select the Software Version item from the Utilities Menu to advance to the software version screen.
2. Press the Back button to return to the Utilities menu.

E. Display Test. The Display Test will test the entire for bad pixels or sectors.



1. Select the Display Test item from the Utilities Menu to advance to the Display Test screen.
2. The test will show a blank screen. If any bad pixels or sectors are detected, those pixels or sectors will be dark. If dark pixels or sectors are indicated, contact the factory repair or replacement options.

3.10 INSTRUMENT : NETWORK MENU

A. Items in the Network menu include Protocol, Address and Baud Rate



B. Protocol: This is the data format for communication between the unit and the host computer. Available values are SPI CCP, Modbus RTU and CAMAC. SPI is the standard Society of Plastics Industry, Inc. protocol. CAC is the CAMAC protocol used on older Milacron machines. Modbus RTU is used in serial communication and is a common serial communications protocol for industrial equipment.



1. Press the Select button to select Protocol.
2. Use the Up or Down arrow buttons to select the preferred protocol.

3. Use the Select button to save the selection and confirm success.

C. Baud Rate: This is the data transfer rate of between the unit and the host computer.



1. Press the Select button to select Baud Rate.
2. Use the Up or Down arrow buttons to select the baud rate. The available rate units are 1200, 2400, 9600, 19200 and 38400.
3. Press the Select button to save the selection and confirm success.

D. Address: This is the number assigned to the unit in a network.



1. Press the Select button to select Address.
2. Use the Up and Down arrow keys to select the address for this unit. The factory default is 1. The selection range is from 1 - 10.
3. Press the Select button to save the address and confirm success.

3.11 INSTRUMENT : FEATURES MENU

A. Items in the Features menu include Autovent Time, Autovent Temp, Pump Seal Cool, Pump Seal Time and Pump Seal Temp.



B. What is Autovent? Autovent is a features built into the controller to purge air from the process system. When the power button is pressed and the process temperature is below the “autovent” (factory default is 100°F) the controller will initiate the autovent cycle



for the “autovent time” (factory default is 45 seconds). When the unit is in the autovent sequence "autovent" is displayed on the home screen. During the autovent sequence the cooling valve is 100% open and pump is running to remove entrapped air from the process.

Air in the system will adversely affect the unit’s ability to control process temperature and can cause heater failure when the heating elements are exposed to this air.

C. Autovent Time. This is the time duration of the autovent.



1. Press the Select button to select Autovent Time item.
2. Use the Up or Down arrow buttons to select the duration of the autovent. The range is 0 - 300 seconds. The factory default is 45 seconds.
3. Press the Select button to save the Autovent time and confirm success.

D. Autovent Temp. This is the process temperature when an autovent can be initiated. On start up, the controller checks the Autovent Temp. If the process temperature is below this value, the autovent will occur. If above this value the autovent will not occur.

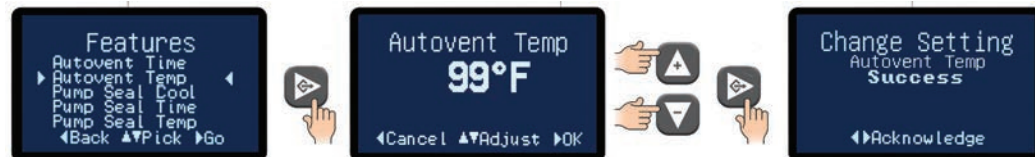

1. Press the Select button to select Autovent Temp item.
2. Use the Up or Down arrow buttons to select the temperature of the autovent. This is the temperature which, if the process temperature is below, will initiate an autovent on startup. The range is 0°F - 300°F. The factory default is 100°F.
3. Press the Select button to save the Autovent temp and confirm success.

E. What is Pump Seal Cooling. Pump seal cooling is a feature that automatically cools the unit to a preselected temperature when the stop button is pressed.

It is a good shut down practice to cool the unit prior to turning the unit off. The pump seal cooling feature automates this process. It is believed that pump seal life can be extended by cooling the unit prior to shutdown. This features opens the cooling valve to discharge hot process water to drain to cool the unit.



WARNING: When the pump seal cooling feature is activated, pressing the stop button will not turn off the unit. To completely shut down the unit, press the Stop button twice.

When activated, the pump seal cooling features is engaged by pressing the stop button once. The cooling valve will open and the pump will continue to run until the pump seal cooling temperature or time limit is met. To stop the unit at any time during this sequence press the stop button again.

When the pump seal feature is activated, pressing the stop button engages the feature. Pressing the stop button twice stops the unit.

To activate the Pump Seal Cooling feature advance to the Pump Seal Cool item and press the Go button to move to the Pump Seal Cool screen. Select Enabled or Disabled and press the Go button to save the selection.

The Pump Seal Cooling feature is controlled by the Pump Seal Time and Pump Seal Time items in the Features menu.



- F. Pump Seal Time.** This controls the duration of the Pump Seal Cooling feature. Upon pressing the Stop button, the Pump Seal Cooling will initiate. For example, if the feature is set at 54 seconds, the Pump Seal Cooling will continue for 54 seconds.



1. Press the Select button to select Pump Seal Time item.
2. Use the Up or Down arrow buttons to select the time of the pump seal cooling feature. The range is 1 - 60 seconds. The factory default is 60 seconds.
3. Press the Select button to save the Pump Seal Time and confirm success.

- G. Pump Seal Temp.** This controls the temperature at which the unit will try to cool to before shutting off. At shut down the controller will initiate the Pump Seal Cooling feature if the process temperature is above this value.

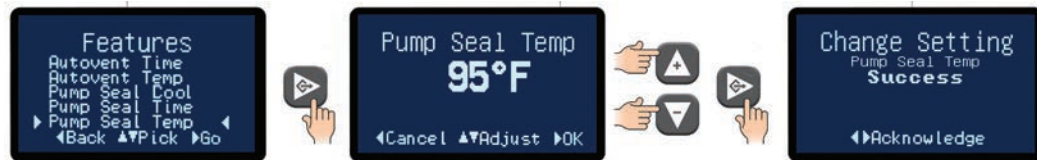

1. Press the Select button to select Pump Seal Temp item.
2. Use the Up or Down arrow buttons to select the temperature of the pump seal cooling feature. The range is 60°F - 100°F. The factory default is 100°F.
3. Press the Select button to save the Pump Seal Temp and confirm success.

3.12 INSTRUMENT : OPTIONS MENU

- A. Two selections are available under the Options menu : Mold Purge and Remote Start/ Stop. These selections will enable or disable these options.

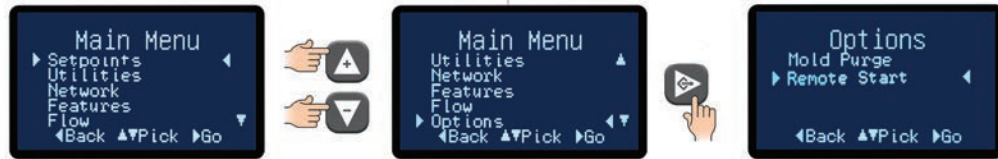

- B. Please note: these options require factory or field installation of optional equipment.
- C. Additional information for the Mold Purge is found in Section 8.3 and the Remote Setpoint is found in Section 8.4.
- D. Mold Purge (optional features not included on all units) :

1. Select Mold Purge from the Options menu.



2. Advance to the Mold Purge Enable / Disable screen. Select Enabled to enable the mold purge feature. Starting a mold or system purge is done by another screen. Refer to Section 3.9.B and 8.3 for more information. Choose disabled to disable the mold or system purge feature.
3. Once acknowledged, press the Back button repeatedly to return to the Options screen or press the home button to return to the Home screen.

- E. Remote Start (optional features not included on all units) :



1. Select Remote Start from the Options menu.
2. Advance to the Remote Start Enable / Disable screen. Select Enabled to enable the remote start feature. Select Disabled to disable the feature. Refer to Section 8.4 for more information.
3. Once acknowledged, press the Back button repeatedly to return to the Options screen or press the home button to return to the Home screen.

3.13 INSTRUMENT : MACHINE MENU

A. The Machine Menu allows the units to set values for the Max Setpoint and Units.



B. **Max Setpoint.** This feature is useful in some application where the setpoint must never be changed above a certain temperature. The Maximum Setpoint can never exceed 300°F in the unit.



1. Use the Up or Down arrow keys to select the Max Setpoint and then press the Select button to save and confirm success.
2. The value range for the Max Setpoint is 32°F to 300°F. The factory default is 300°F.

D. **Units.** This screen controls how the temperature is displayed. The options are English (°F) or Metric(°C). Also, when the optional flow meter is installed, the flow will display in GPM if English is selected or LPM if Metric is selected.

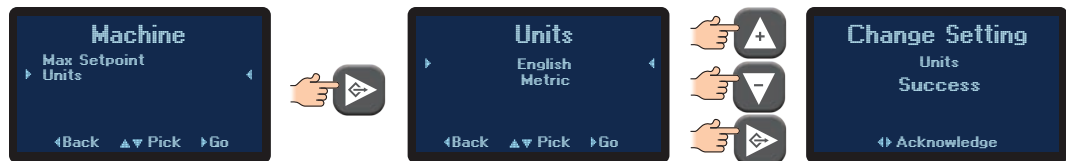

1. Use the Up or Down arrow keys to select the Unit display and then press the Select button to save and confirm success.
2. The factory default value is English.

3.14 SHUT DOWN - DISCONNECT

A. UNIT SHUT DOWN

1. Decrease the setpoint temperature lower than 85°F and allow the unit to cool to the temperature. A pump seal cooling feature can be selected from the features menu to automatically cool the unit once the stop button is pressed.

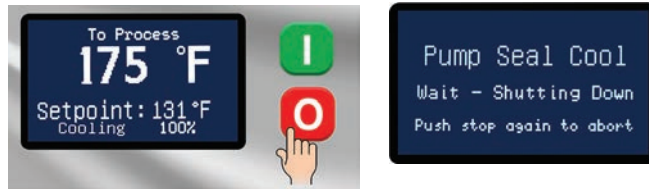

2. Press the stop button.
3. Relieve residual static pressure before disconnecting or servicing the unit.
4. Follow all lock-out tag-out requirements.

4.0 TROUBLESHOOTING

- 4.1 Unit will not start (Display is not Illuminated)
- 4.2 Unit will not start (Display Illuminated)
- 4.3 Unit Stops
- 4.4 Unit Overheats
- 4.5 Unit Underheats
- 4.6 Pressure Relief Valve Leaks



4.1 UNIT WILL NOT START (DISPLAY IS NOT ILLUMINATED)

- A. One or more fuses at the main disconnect device are open (blown). Determine continuity at each fuse. If continuity is not determined, replace the fuse. Then determine cause of blown fuse.
- B. Control circuit transformer fuse is open (blown). Determine continuity at the control circuit transformer fuse. If continuity is not determined, replace the fuse.

4.2 UNIT WILL NOT START (DISPLAY ILLUMINATED)

- A. **Power supply is ON.** The operator can determine that electrical power supply to the unit is “on” when the instrument display is illuminated. Even with the main power supply on, the unit is prevented from operating by one of the following conditions:

- 1. **Water supply pressure inadequate.** The display shows a Fault : System Safety screen. The unit is prevented from operation without adequate water supply pressure by the electrical panel mounted pressure switch. Sufficient water supply pressure must be present to close the switch. Refer to Section 2.3 for additional information.



System Fault Screen.
Indicates a water supply or a pump overload fault.

- 2. **Motor overload switch opened.** This display shows a Fault : System Safety screen. The electric motor is protected from overload conditions by a set of thermal overload relays. These relays will open (trip). If the overload relay is open, it must be reset before operation can continue. An excessive flow condition must be isolated and corrected immediately.

- 3. **High temperature limit switch open.** The display shows a Fault : System Safety screen. The unit is prevented from operations at temperatures exceeding 310°F by a “high temperature limit switch”. This switch is installed in the *To Process* temperature sensor. If this switch is open (due to a high temperature condition), the unit cannot be started and must “cool down” before the “high temperature limit switch” will automatically reset.



High Temp Limit Fault
Screen.

4.3 UNIT STOPS

- A. The operator should determine the main power supply to the unit is **ON** by an illuminated display. With the main power supply “on”, the unit will be prevented from starting by the following conditions:

- 1. **Water supply pressure inadequate.** The display shows a Fault : System Safety screen. The unit is prevented from operation without adequate water supply pressure by the electrical panel mounted pressure switch. Sufficient water supply pressure must be present to close the switch. Refer to Section 2.3 for additional information.



System Fault Screen.
Indicates a water supply or a pump overload fault.

2. **Motor overload switch opened.** The display shows a Fault : System Safety screen. The electric motor is protected from overload conditions by a set of thermal overload relays. These relays will open (trip). If the overload relay is open, it must be reset before operation can continue. An excessive flow condition must be isolated and corrected immediately.
3. **High temperature limit switch open.** The display shows a Fault : System Safety screen. The unit is prevented from operations at temperatures exceeding 310°F by a “high temperature limit switch”. If this switch is open (due to a high temperature condition), the unit cannot be started and must “cool down” before the “high temperature limit switch” will automatically reset.



High Temp Limit Fault Screen.

4.4 UNIT OVERHEATS

- A. This is evidenced by To Process temperatures consistently above the selected setpoint temperature. Overheating is also evidenced by a To Process temperature that continues to escalate above the setpoint temperature with no apparent cooling action, even though the blue Cool icon is displayed. Extreme overheating is evidenced by To Process temperatures over 310°F. The operator should check for the following conditions:
 1. **Inadequate water supply pressure.** The unit must be supplied with adequate water flow to provide cooling when required. The minimum pressure differential between the water supply and drain to achieve full cooling capacity is 10 PSI. The minimum water supply pressure is 20 PSI for setpoints from 180°F and under. A chart in Section 2.3 lists water supply pressures for setpoint above 180°F. A drop in water supply pressure operation will cause the pump to stop and a safety fault to be displayed.
 2. **Cooling valve defective.** The instrument opens and closes the cooling valve as prescribed by the current process load. If the valve becomes clogged with process water debris or scaled with mineral deposits, its operation is hindered or fully prevented and adequate process water discharge to drain is prevented. The operator must service the cooling valve and remove any loose debris. Massive debris or scale deposits may necessitate replacement of the internal valve.
 3. **Drain line obstruction.** The operator must determine if the drain line is obstructed by the following conditions. Section 2.4 outlines the parameters of correct drain line installation.
 - a. **Closed drain line valve.** An installed but partially or fully closed valve in the drain line prevents full discharge to drain and contributes to an overheating condition. The operator should determine the drain line is open.
 - b. **High drain back pressure.** Pressurized plant drain lines will prevent flow to drain if the differential between the water supply pressure and the drain line pressure is inadequate. The factory recommended minimum differential is 20 psi. If the differential is less than the factory recommendation, plant service personnel should take measures to reduce drain line pressure.

4. **Instrument defective.** The instrument is life-tested and found to be field reliable. However, in the case where the instrument is determined to be defective, the operator contact the Service Department for information. The instrument is not a field serviceable component.

4.5 UNIT UNDERHEATS

- A. This is evidence by operations with To Process temperatures consistently below the selected setpoint temperature.
 1. **Process water leakage.** When the instrument engages the heater to elevate process temperature, the input of heat into the process can be offset by a defective cooling valve. If the cooling valve is defective, it may pass a larger than required stream to drain, thus providing unwanted cooling. A defective cooling valve should be repaired immediately.
 2. **Heater element failure.** A failed heater element will not input adequate heat into the process to elevate the process water temperature. The operator must check the amps at the heater contactor with the contactor energized. Zero amps at the contactor indicate a failed heater or burnt wire connections. The operator should remove the failed heater and replace with a new heater according to the procedure outlined in section 5.2.
 3. **Unit capacity too low.** This occurs when the process requires more heat than the unit is capable of producing. The only option in such cases is to install a unit with an adequate heater kW rating for the load.
 4. **Instrument defective.** The instrument is life-tested and found to be field reliable. However, in the case where the instrument is determined to be defective, the operator contact the Service Department for information. The instrument is not a field serviceable component.

4.6 PRESSURE RELIEF VALVE LEAKS

- A. The unit has a 150 psi pressure relief valve mounted in the cooling cylinder. If the valve is found to be leaking, the operator should check the following:
 1. **Water supply pressure exceeds 75 psi.** The unit is designed to operate with water supply **NOT** exceeding 75 psi. See section 2.3 paragraph B for specific water supply pressure requirements at corresponding setpoint temperatures. If the plant water supply pressure exceeds 75 psi, the pressure relief valve may leak. Static water supply pressure can be determined at the unit's location by reading the unit's 0-160 PSI pressure gauges when the unit's motor pump is off. If the water supply pressure at the unit's location exceeds 75 PSI, a pressure reducing valve must be installed in the water supply line. The factory recommended 'regulated pressure out' is 55 PSI. Refer to section 7.3 for regulator installation drawing.
- B. **Back flow prevention device in water supply line.** If a back flow prevention device (check valve, pressure regulator, closed valve) is installed in the water supply line, increased pressures from thermal expansion are unable to move into the water supply line. This will increase the unit's internal pressure causing the pressure relief valve to



leak. Refer to section 7.3 for regulator installation drawing.

- C. Valve contamination.** The pressure relief valve may become contaminated with water debris causing the valve not to close properly. If this is the case, flushing the valve for a moment will cleanse the seat and allow it to work properly. If flushing the valve does not remedy the leaking, the valve must be replaced.

- D. Extreme internal system pressure.** If the internal pressure in the unit is elevated, the pressure relief valve will leak as a safety measure to dissipate excessive pressure. If this is the case, the operator must determine why the system internal pressure is excessive and correct the condition.



THIS PAGE INTENTIONALLY BLANK

5.0 SERVICE/MAINTENANCE

- 5.1** Pump Seal Replacement
- 5.2** Heater Replacement
- 5.3** Cooling Valve Service
- 5.4** Voltage Change
- 5.5** Sensor Probe Service
- 5.6** Pressure Switch Service
- 5.7** Electronic Instrument Repair Policy & Procedure
- 5.8** Temperature Probe Calibration
- 5.9** Heater Contactor and Pump Motor Starter



5.1 PUMP SEAL REPLACEMENT

- A.** The pump seal is a carbon/ceramic shaft seal assembly including a stationary member, rotating member and tension spring.
- B.** The life cycle of the pump seal is determined by hours of use, operating temperature and water quality. Poor water quality is the primary reason for premature pump seal failure.
- C.** The operator should follow this procedure to replace the pump seal:
1. Disengage process operations and relieve all system pressure.
 2. Disengage main power supply. Verify the *Power* light on the display is “off”.
 3. Remove the lift-off access panel and set aside.
 4. Remove the necessary panels to gain access to the pump motor.
 5. Drain machine by removing the pump casing drain plug.
 6. Remove the three motor wire leads from the motor wiring terminals. The operator should “map” the wire terminal locations to ensure correct rewiring. The power cord should be removed from the motor housing.
 7. Locate and remove the 4 pump casing bolts. These bolts secure the motor and motor adapter to the pump casing.
 8. Separate the motor and adapter from the pump casing to expose the pump impeller. Remove the motor and adapter from the unit and place on a workbench to continue the procedure.
 9. Locate and remove the dust cap from the motor to expose slotted motor shaft.

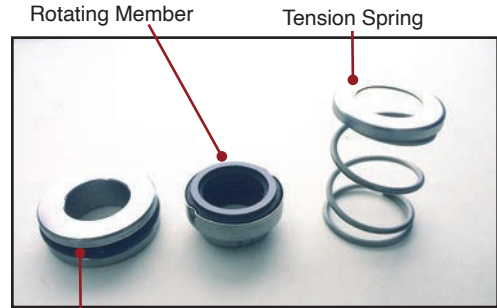

Stationary member



Pump Motor

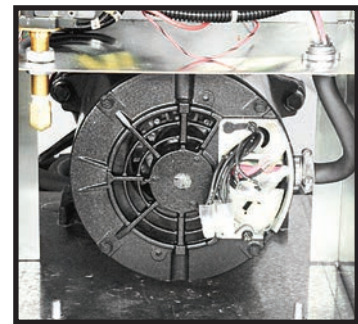

Motor leads

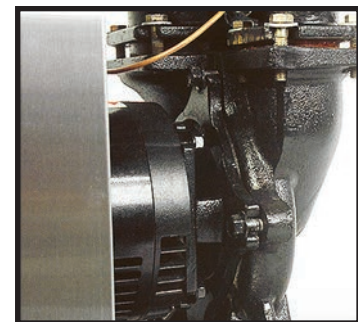

Pump casing bolts

The motor shaft is free to rotate, but must be secured to remove the impeller. To secure the motor shaft, insert a flat bladed screw driver in slot to hold the shaft stationary.

10. Locate and remove impeller locking screw. Using a socket and ratchet, the impeller retaining screw can be removed. Once removed, the impeller can be “unthreaded” from the motor shaft to expose the pump seal assembly.
 11. Remove all seal parts. Note seal component arrangement to facilitate reassembly.
 12. Clean the motor shaft and lubricate with a mild soap solution. **Note: Oil must never be used as a lubricant as it will damage the rubber parts of the seal assembly.**
 13. Install new stationary seal member in pump casing cavity. Be certain the stationary seal member is fully squared and seated in cavity.
 14. Slide the rotating member onto the lubricated pump shaft. Be certain not to damage or tear the rubber bellows assembly.
 15. Place the spring onto the rotating member.
 16. Align the tension spring and rotating member before reinstalling the impeller. Be certain the spring and rotating member are aligned before the impeller is fully tightened and the impeller retaining screw is reinstalled.
 17. Clean the pump casing, cavities, impeller and O-ring before reassembly.
 18. Mate the motor and adapter to the pump casing. Reinstall the 4 pump casing bolts.
 19. Reconnect the motor power cord and leads.
 20. Replace the thermoformed front panel and the lift-off cover.
- D. When this procedure is complete, the operator may restart the unit. In many cases, a new pump seal will experience a small amount of leakage for a short

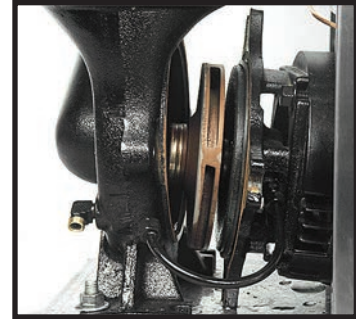

Impeller



Motor shaft

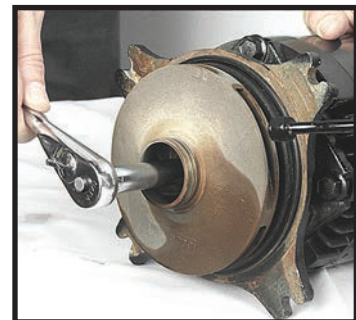

Removing impeller locking screw with ratchet



Seal components

time. This is normal. After a few moments, the new seal will take seat and the leak will stop.



Seal components Figure 5.1I



Stationary member Figure 5.1J



Rotating member Figure 5.1K



Aligning impeller and spring Figure 5.1L

5.2 HEATER REPLACEMENT

- A. The heater is a flange mounted assembly and inserted into the cast cylinder tank and secured by 4 bolts.
- B. The operator can determine if the heater requires replacement when the heater draws "0" amps or when a continuity check of each heater element is negative.
- C. Generally, heaters fail due to low water flow, low water pressure, air in the system or defective heating elements.
- D. The operator should follow this procedure to replace the heater:
 1. Disengage operations and be certain all system pressure is relieved and the unit's pressure gauges read "0".
 2. Disengage main power supply. Verify the *Power* light on the display is "off".
 3. Remove the lift-off access panel and set aside
 4. Drain machine. The machine can be drained by removing the pump casing drain plug.
 5. Remove heater's junction box cover to locate wiring connections. The operator should note the wiring connections to ensure correct reinstallation.
 6. Disconnect the three power leads from the heater terminals. Remove the power cord from the junction box.
 7. Remove the 4 heater mounting bolts.
 8. Remove heater.
 9. Before the new heater is installed, the mating surface of the cast tank should be cleaned. Once cleaned, place the new heater gasket onto the tank mating surface. Coat the mating surface with a high temperature gasket sealant.
 10. Set new heater into tank. Aligning the bolt pattern of the heater and tank flanges.



Heater

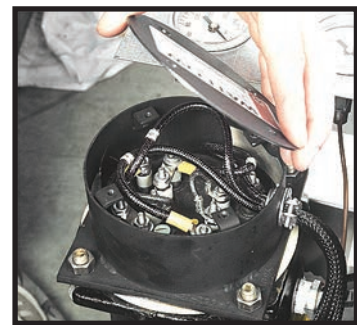

Heater junction wires



Heater mounting bolts

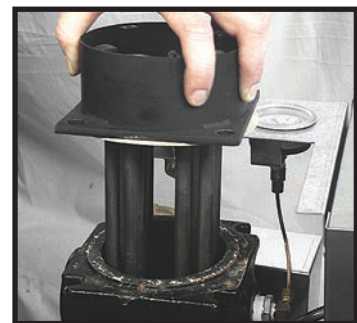

Remove heater

5.3 COOLING VALVE SERVICE

- A. The unit uses the PVT™ (Pulsed Valved Technology) solenoid valve (figure 5.3A) as the cooling valve. The solenoid valve is controlled by the instrument.
- B. Generally, the PVT™ valve require service for a failed coil or more often it will not fully close because debris from poor make-up water quality is in the valve mechanism.
- C. To service the solenoid valve follow the procedure below.
 - 1. Disengage process operations according to the procedure outlined in **section 3.4**. Be certain process fluid pressure is relieved (coolant pressure gauge reads “0”) and water system flow is shut off.
 - 2. Disengage main power supply. The operator must follow all lockout/tagout procedures.
 - 3. Remove or open any access cover panel and set aside to gain access to the make-up solenoid valve.
 - 4. The solenoid valve can be disassemble by removing the 4 retaining screws.
 - 5. Keeping all electrical connections intact, lift the coil and top solenoid base assembly and set aside.
 - 6. **Note the arrangement of the core spring and core assembly, diaphragm spring and diaphragm assembly.** (See diagram.)

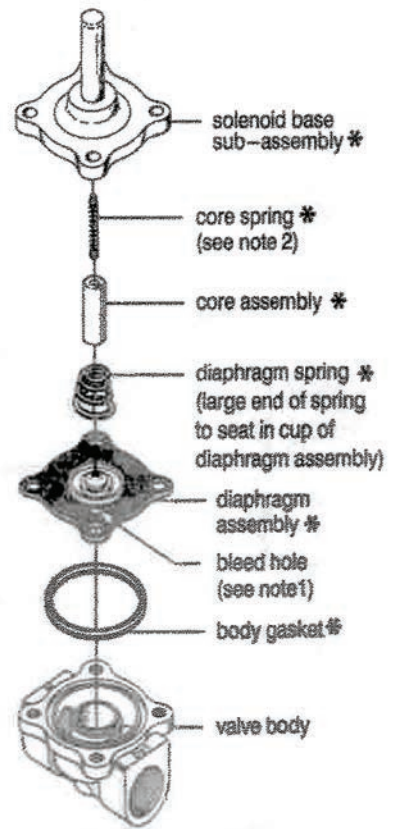

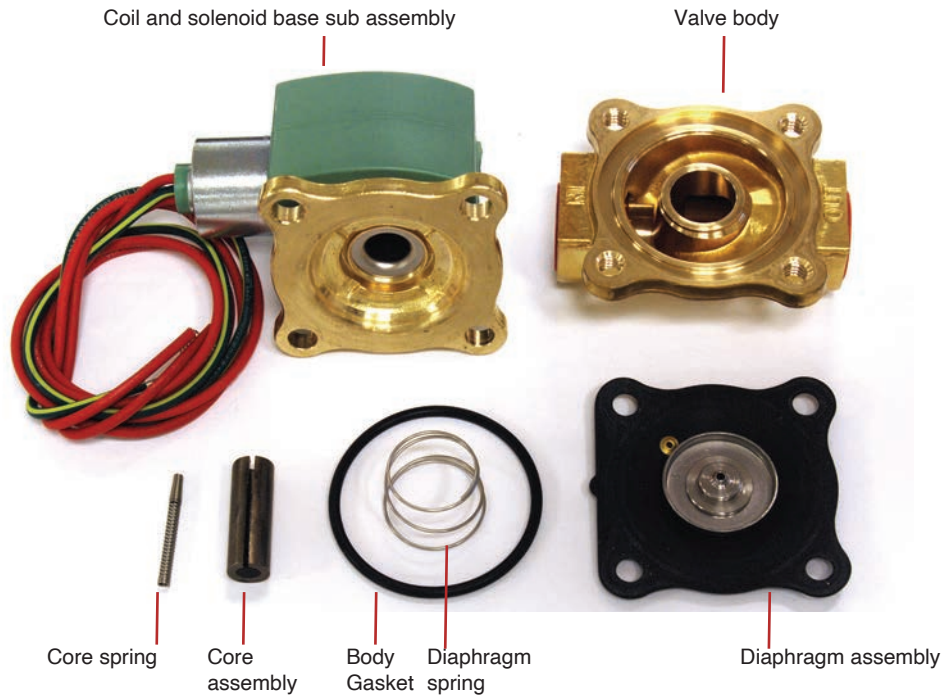

5.4 VOLTAGE CHANGE

A. Some units can undergo a field voltage conversion by qualified technicians. Consult with the Service Department to determine if your unit can be converted. Have your Serial Number ready and call 317-887-0729.

B. Typical Conversions for 1/2 to 7.5 horsepower motors and 10 to 16 kW heaters:

1. 240/3/60 to 480/3/60
2. 480/3/60 to 240/3/60
3. 480/3/60 to 208/3/60

Consult factory for other power conversions.

C. For a field voltage changeover, the following items will require replacement or rewiring:

1. Heater (rewiring)
2. Motor (rewiring)
3. Transformer (rewiring)
4. Motor starter and overload block (replace)
5. Replace unit data tag with tag stating new voltage and amp rating.

Motor Starter and Overload Block

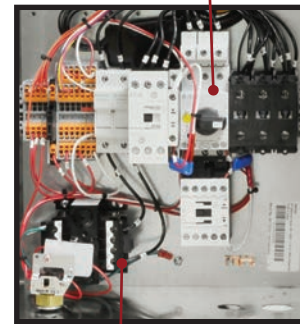

Transformer

D. The qualified technician should follow this procedure to complete a field voltage changeover:

1. Disengage operations and verify all system pressure is relieved and the unit's pressure gauges read "0".
2. Disengage main power supply. **Follow proper lock-out procedures.** The operator must verify the *Power* light on the display is "off".
3. Gain access to the electrical panel.



Typical electrical panel.

- Rewire the heater to the new voltage. Schematics for heater brands used in typical temperature control units are shown below.

Wiring Schematic for Watlow Brand Heaters : 10 kw & 16 kW

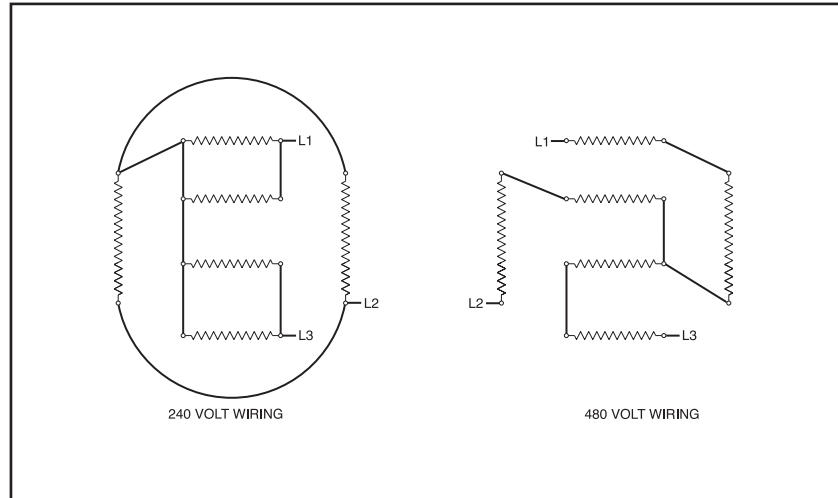

Wiring schematics for 240 and 480 volt heaters Revised 4/11

Wiring Schematic for Tempco Brand Heaters : 10 kw & 16 kW

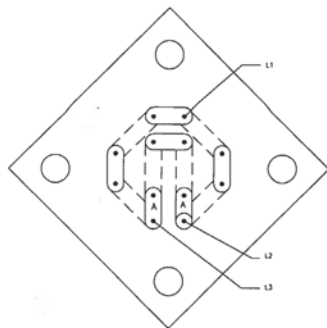
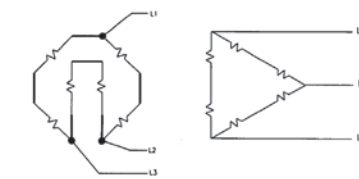

Figure 1



WIRING SCHEMATIC

480 VOLT WIRING (AS SHIPPED)

TOP VIEW (HOUSING NOT SHOWN)

Going from 480 volt to 240 volt:

- Use KTT00274 wiring kit which includes jumpers needed to re-wire the unit
- Move sheet metal busbars (item A) to different location (see Fig 2)
- Add busbar B (see Fig 2)
- Install wire jumper (item C) to connect them (see Fig 2)

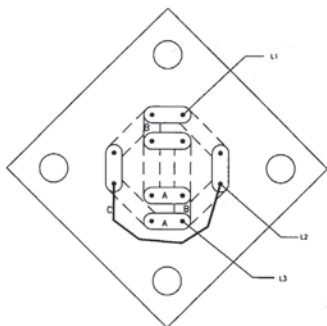
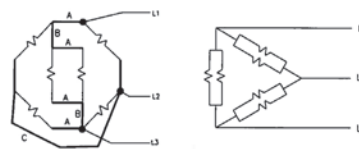

Figure 2



WIRING SCHEMATIC

240 VOLT WIRING

TOP VIEW (HOUSING NOT SHOWN)

Going from 240 volt to 480 volt:

- Move sheet metal busbars (item A) to different location (see Fig 1)
- Remove busbar B (see Fig 1)
- Remove wire jumper (item C)

5. Remove the thermoformed front panel and open the electrical cabinet panel door. Unplug the instrument connectors to fully extend the hinged panel.
6. Rewire the pump motor for the new voltage. Most Sentra pump motors are dual voltage. The drawing schematic below shows the wiring schematic for 240 and 480 voltages.

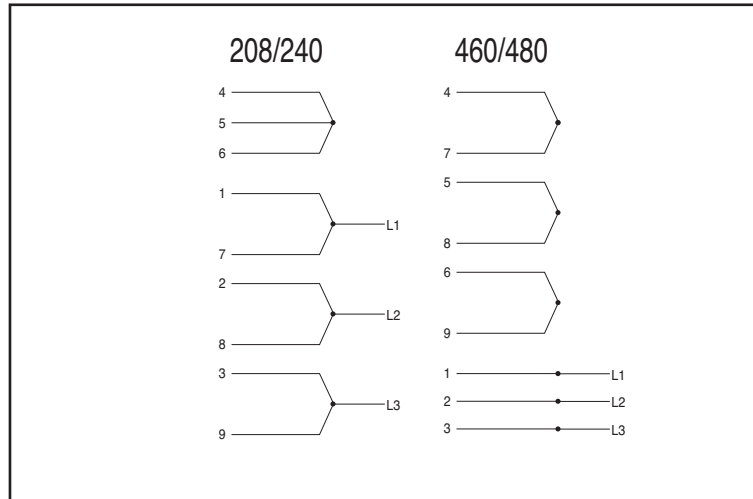

Wiring schematics for 240 and 480 volt pump motors

7. Rewire the transformer to the proper voltages as shown by the schematic on the transformer.
8. Replace the motor starter and overload block. Adjust the overload block settings for the current draw at the new voltage.
9. Once a voltage change is complete, be certain the unit is properly connected to the new voltage supply, as outlined in **section 2.5** of this manual. Restart unit operations according to **section 3** of this manual.

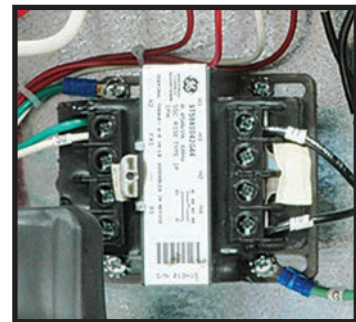

Typical Transformer

Motor Starter and Overload Block

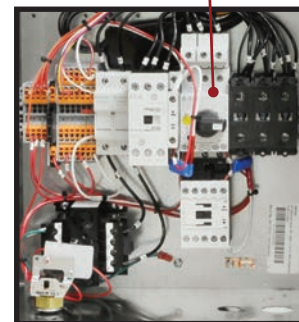

5.5 SENSOR PROBE SERVICE

- A.** The temperature probe is a temperature transducer. The transducer is embedded into a bulb well, which is threaded into the tank. The transducer converts the temperature of the water into a proportional current output, which the microprocessor controller reads, displays, and bases its controlling functions on. The gain is automatically calibrated within the controller electronics, the zero adjustment potentiometer is located on the CPU.

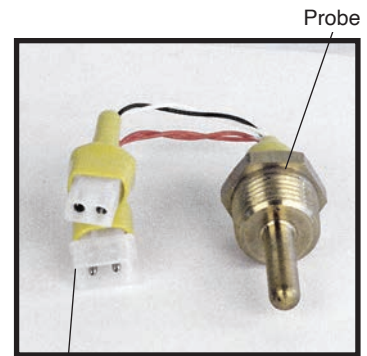

- B.** Sensor probe errors are indicated by the Probe Fault screen. When a sensor probe error is displayed, take the following steps to correct:

1. **RECONNECTION.** If the service connection becomes saturated with water simply unplug the connection, shake out the water and replug. If this was the problem, the yellow Alert icon will disappear. If not, continue with replacement.
2. **REPLACEMENT.** All factory supplied replacement probes are complete with the service connection. The unit uses two sensor probes. The “high temperature limit” safety switch is a part of the to process probe. To replace follow the procedure as outlined below:
 - a. Stop process operations as described in section 3.4 of this manual.
 - b. Determine that all process pressure is relieved and the unit’s pressure gauges read “0” pressure.
 - c. Drain the unit by removing the pump casing drain plug. The unit can be drained below the sensor probe mount if preferred.
 - d. Disconnect the sensor probe service plug.
 - e. Using a crescent wrench, remove the sensor probe from the cylinder. To install a new sensor probe continue as follows:
 - f. The new sensor probe threads should be lined with teflon tape and coated with leak preventative sealant. Using a crescent wrench, thread the new sensor into the machined boss of the cylinder.
 - g. Reconnect the service connection. Restart the unit as outlined in section 3 of this manual.



Sensor Probe Fault Screen.

5.6 PRESSURE SWITCH SERVICE

- A.** The unit is protected from low pressure operations by a pressure switch. This switch is mounted at the bottom of the electrical cabinet.
- B.** The switch will close and consent the control circuit when sufficient water supply pressure is presented. The switch is factory set to 20 psi.
- C.** If insufficient water supply pressure is present, the switch will open and prevent operations.
- D.** In cases where sufficient water supply pressure is present as indicated by the unit's pressure gauges and the pump is "off", and if the pressure switch fails to close, the pressure switch may be defective. To replace the pressure switch, follow the steps outlined:
1. Shut down unit operations according to section 3.4 in this manual. Be certain proper lock-out procedures are followed. Also, be certain system pressure is eliminated and the unit's pressure gauges read "0" pressure.
 2. Drain unit by removing the pump casing drain plug.
 3. A capillary runs from the cooling cylinder to the pressure switch. Remove the capillary connection.
 4. The brass elbow mounted on the pressure switch must be removed.
 5. Remove the electrical connections to the pressure switch.
 6. The pressure switch is mounted onto the electrical cabinet with two 1/2" nuts in series. Remove the nuts to remove the pressure switch. A new pressure switch from the factory should be installed by continuing with step 7.
 7. Thread one 1/2" nut onto the pressure switch and then place the pressure switch through the panel in the original mounting hole. Thread the second 1/2" nut from the bottom of the pressure switch. Tighten to lock the pressure switch in place.
 8. Install the brass elbow fitting. Teflon tape and leak preventative paste should be used to prevent water leakage. Install the capillary tube and resume operations.

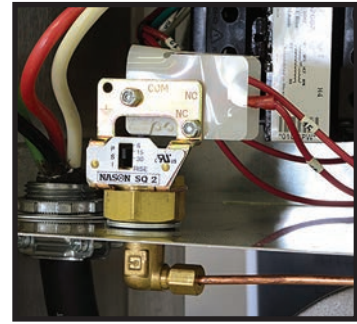

Pressure switch

5.7 ELECTRONIC INSTRUMENT REPAIR POLICY AND PROCEDURE

- A.** All control instruments used in temperature control units are covered by the machine's warranty. Proprietary 'tailor made' instrument are manufactured specifically for the Manufacturer.
- B. IN WARRANTY SERVICE INCIDENT**
1. Call the factory for diagnostic assistance.
 2. If a control instrument is determined to be at fault, a new or reconditioned instrument will be sent as a replacement.
 3. Return the defective instrument freight pre-paid for full credit. If the defective instrument is not returned you will need to pay for it.
- C. OUT OF WARRANTY SERVICE INCIDENT**
1. Call the factory for diagnostic assistance.
 2. If a control instrument is determined to be at fault, there are 3 options.
 - a. Purchase a new instrument as a replacement.
 - b. Send your instrument back for repair, freight prepaid. For a nominal fee, your instrument will be repaired and returned.
 - c. Purchase a new instrument and repair the old one as a back up.
 3. If you are sending your instrument back for repair, call the Service Department for more information. Do not disassemble the instrument.
- D. Other Information:**
1. Call the factory for current repair charges.
 2. Repair warranty: 1 year.
 3. Ship to 525 East Stop 18 Road, Greenwood, IN 46143. Attention: Repairs (317-887-0729). Include in the shipping box: Part, purchase order, contact name, phone number, and symptom (if available).



5.8 TEMPERATURE PROBE CALIBRATION

A. Equipment Needed:

1. Potentiometer adjustment tool / flat-blade screw driver (tip width of 0.050" or less works best)
2. Temperature reference (ice water bath)
3. 1/2" plug
4. Digital thermometer
5. Screwdriver (chassis disassembly)

B. Setup:

1. Disengage process operations according to the procedure outlined in the unit manual. The operator must be certain all system pressure is relieved and unit pressure gauges read "0".
2. Disengage main power supply.
3. Remove the "to process" temperature probe and insert a 1/2" plug in its place.
4. Prepare an ice bath (a cup of water with lots of ice). You should place a digital thermometer in the ice bath to read the temperature of the bath. Place the probe in the ice bath.

C. Procedure:

1. Restart the instrument according to the procedures outlined in the unit manual.
2. Reduce the unit's setpoint to its lowest setting.
3. The "to process" temperature on the display should equal the temperature of the ice bath as indicated by the digital thermometer. If not, change the calibration.
4. The calibration potentiometer is located on the top of the CPU board. To access it, open the electrical cabinet panel door. Caution must be employed when the electrical panel door is open since power is applied to unit.



WARNING: Electrical power is engaged and caution should be employed while the cabinet is open.

5. Locate the "to process" calibration potentiometer using Figure 1 as a guide. Use the small screwdriver to turn the potentiometer.

6. Adjust the potentiometer until the “to process” temperature on the display equals the temperature of the ice bath.
7. When the two temperatures are equal, the calibration procedure is complete.
8. **Stop the unit following the shutdown procedure described in the manual and place all process probes back in the unit to return to normal operation.**

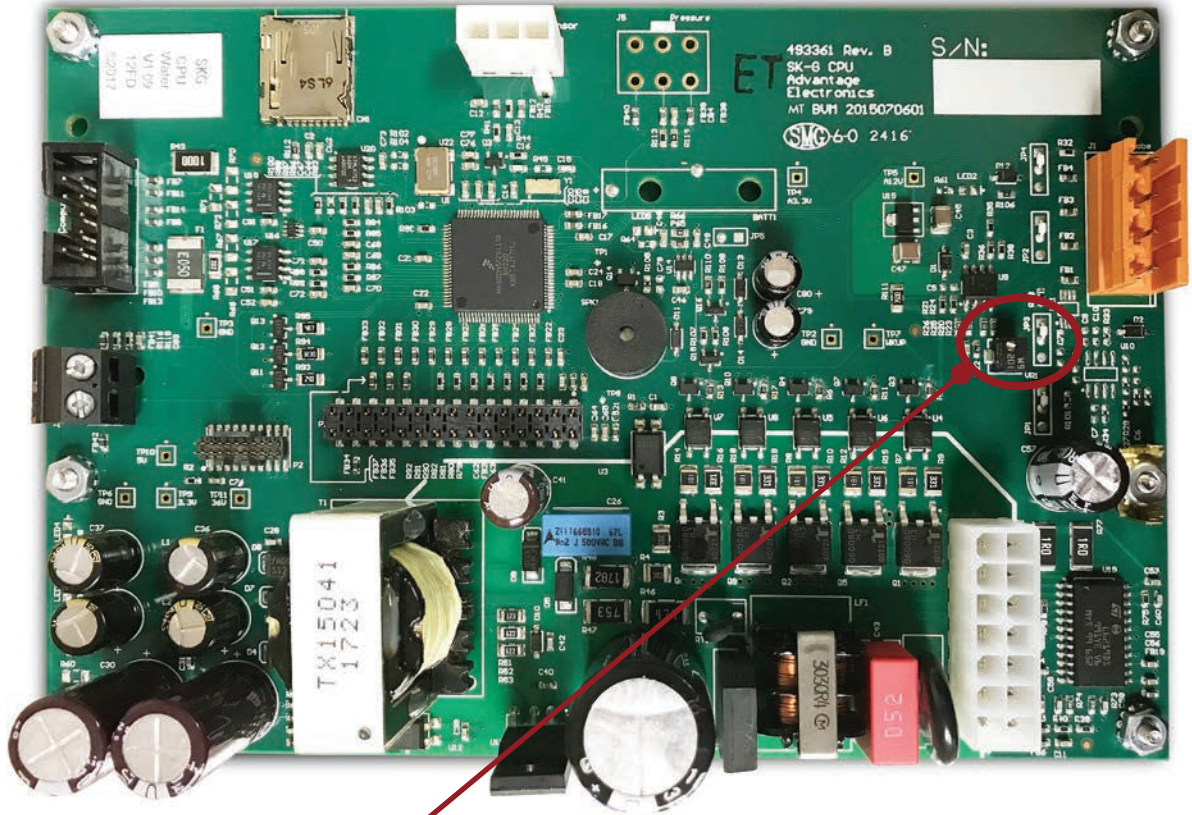

Calibration potentiometer

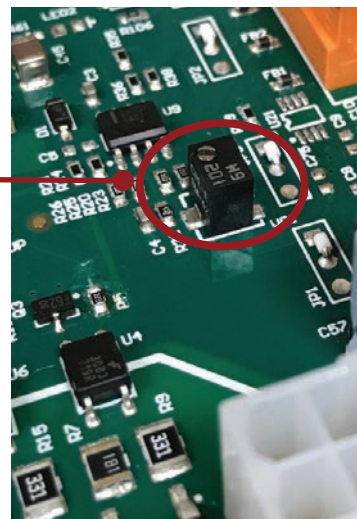

5.9 HEATER CONTACTOR & PUMP MOTOR STARTER

- A. The “standard” mechanical contactor for the heater will cycle proportionally to the amount of heat input required for the process and may cycle frequently.
- B. This is a “wear” item that must be routinely inspected and replaced when the contacts begin to indicate wear/pitting.
- C. Failure to maintain the contactor may result in overheating of the components and catastrophic electrical failure.
- D. The “standard” mechanical pump motor starter must also be routinely inspected and replaced when the contacts begin to indicate wear/pitting.

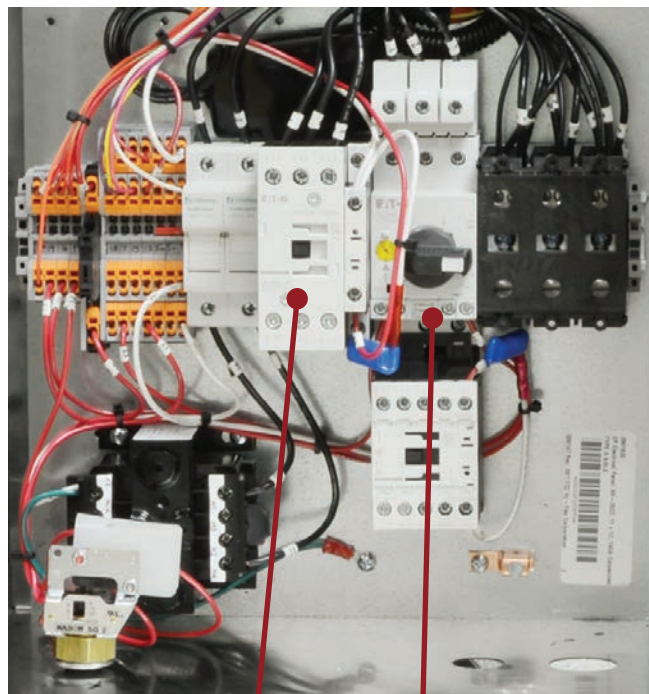

Typical electrical panel.

Typical Heater Contactor

Typical Pump Motor Starter



WARNING: Failure to maintain the contactor may result in overheating of the components and catastrophic electrical failure.

6.0 COMPONENTS

6.1 Mechanical System

6.2 Electrical System



6.1 MECHANICAL SYSTEM

- A. Pump Casing/Cooling Tank/Heater tank.** The pump casing/cooling/heater casting is an exclusive design (Standard 1/2-3 horsepower models). The pump casing is designed for high efficiency performance and houses the pump impeller. The integral heater tank houses the flange mounted immersion heater and the integral cooling tank provides a mixing chamber for return from process fluid and cooling water. The assembly is fastened to the unit base for support.
- 1. Pump adapter.** The pump adapter is the mating element between the pump casing the electric motor. The adapter is machined to accept the pump seal flush line. The stationary pump seal member is set in the seal cavity of the pump adapter.
 - 2. Electrical motor.** The electric motor is a dual voltage, 3 phase, ODP motor. The motor serves to turn the pump impeller creating process flow.
 - 3. Impeller.** The impeller is driven by the electric motor and rotates within the pump casing to create high flow rates.
 - 4. Pump Seal.** The pump seal prevents water leakage from the pump adapter. The seal is made up of three items: The stationary member (seated in the seal cavity), the rotating member (placed on the motor shaft) and the tension spring.
- B. HEATER.** The heater is a flanged immersion type heater mounted in the discharge housing of the pump. The heater elements have a stainless steel sheath. A mechanical contactor is engaged and disengaged by the control instrument to maintain the set point temperature. An optional solid state heater contactor is sometimes used in lieu of the mechanical contactor. The heater must remain submerged in water at all times.
- E. PRESSURE RELIEF VALVE.** The pressure relief valve is a 150 psi relief valve serving to discharge excessive unit pressure to atmosphere. The valve can be manually activated by lifting the actuating lever.
- F. COOLING VALVE.** The AVT™ valve modulating valve is a patented design using a motor/gearbox assembly to open in minute increments from 0 to 100% a custom ball valve assembly. The AVT™ valve is controlled by custom programming of the instrument and only available on unit with G & T control instruments. On units with the V, G300 & T300 a pulse metered solenoid valve is used. The cooling valve controls the flow of cooling water from the water supply source.
- G. PRESSURE GAUGES.** “To” and “from” process pressure gauges display the system pressure. “To process” pressure originates at the heat/pump discharge cylinder. “From process” pressure originates at the cooling cylinder. The gauges accurately display system pressures from 0 to 160 PSI.
- H. CASTERS.** The unit is mounted on 4 swivel ball bearing casters. The casters allow the unit to be portable and easily move from location to location.
- I. STAINLESS STEEL CABINetry.** The stainless steel cabinetry prevents unsightly rust and metal decay. The electrical cabinet cover is hinged. The unit base is made of pressed steel with galvanized zinc coating. The rear access panels can be lifted off after removing the fasteners.



6.2 ELECTRICAL SYSTEM

- A. INSTRUMENT.** The instrument is a custom designed and assembled microprocessor controller. The instrument is mounted to the electrical panel cover. The instrument controls the cycling of the heater, motor pump and AVT™ cooling valve. System and setpoint temperatures are displayed continually. System parameters are programmable..
- B. TRANSFORMER.** The transformer supplies 110 volts to the controlling instrument.
- C. PUMP MOTOR CONTROLLER.** The electrical motor is engaged when the motor starter contacts close, on command by the instrument. The electric motor is protected from excessive amperage by a set of thermal overload relays, which open when excessive amperage “heats” the overloads and the relay opens.
- D. HEATER CONTACTOR.** The standard heater contactor is a mechanical style contactor. On command from the instrument, the contactor will close and voltage will be supplied to the heater. The contactor use should be monitored and the contactor should be replaced as needed based on duty cycle. Some units are provided with a solid state contactor rather than the standard mechanical contactor.
- E. PRESSURE SWITCH.** The electric panel mounted pressure switch will close when sufficient pressure is supplied to the unit (20 psi). A closed pressure switch will consent the control circuit to the instrument controller to allow process operations.
- F. SENSOR PROBES.** The unit uses 1 sensor probe. The sensor and the “high temperature limit” safety switch” are housed in the same assembly and mounted in the heater/pump discharge tank. The “from process” probe is mounted in the suction tank.
- G. POWER CORD.** On standard models with 10kW and 16kW heaters and 1 - 3 HP pumps are supplied with a 3 conductor with 1 ground wire sized for the unit and 10' in length. Standard models with 24kW and 34kW heaters are not supplied with a power cord and the customer must provide a 3 conductor with 1 ground wire sized for the unit.



THIS PAGE INTENTIONALLY BLANK

7.0 RELATED DRAWINGS

- 7.1 Physical : Cabinet Style for Units up to 16 kW Heaters and Pumps to 3 HP
- 7.2 Physical : Cabinet Style for Units with 24 & 34 kW Heaters and Pumps to 3 HP
- 7.3 Physical : Cabinet Style for Units with 5 & 7.5 HP Pumps
- 7.4 Regulator / Bypass
- 7.5 Dual Zone Dolly
- 7.6 Stacking Rack



7.1 PHYSICAL : Cabinet Style for Units up to 16 kW Heaters and Pumps to 3 HP

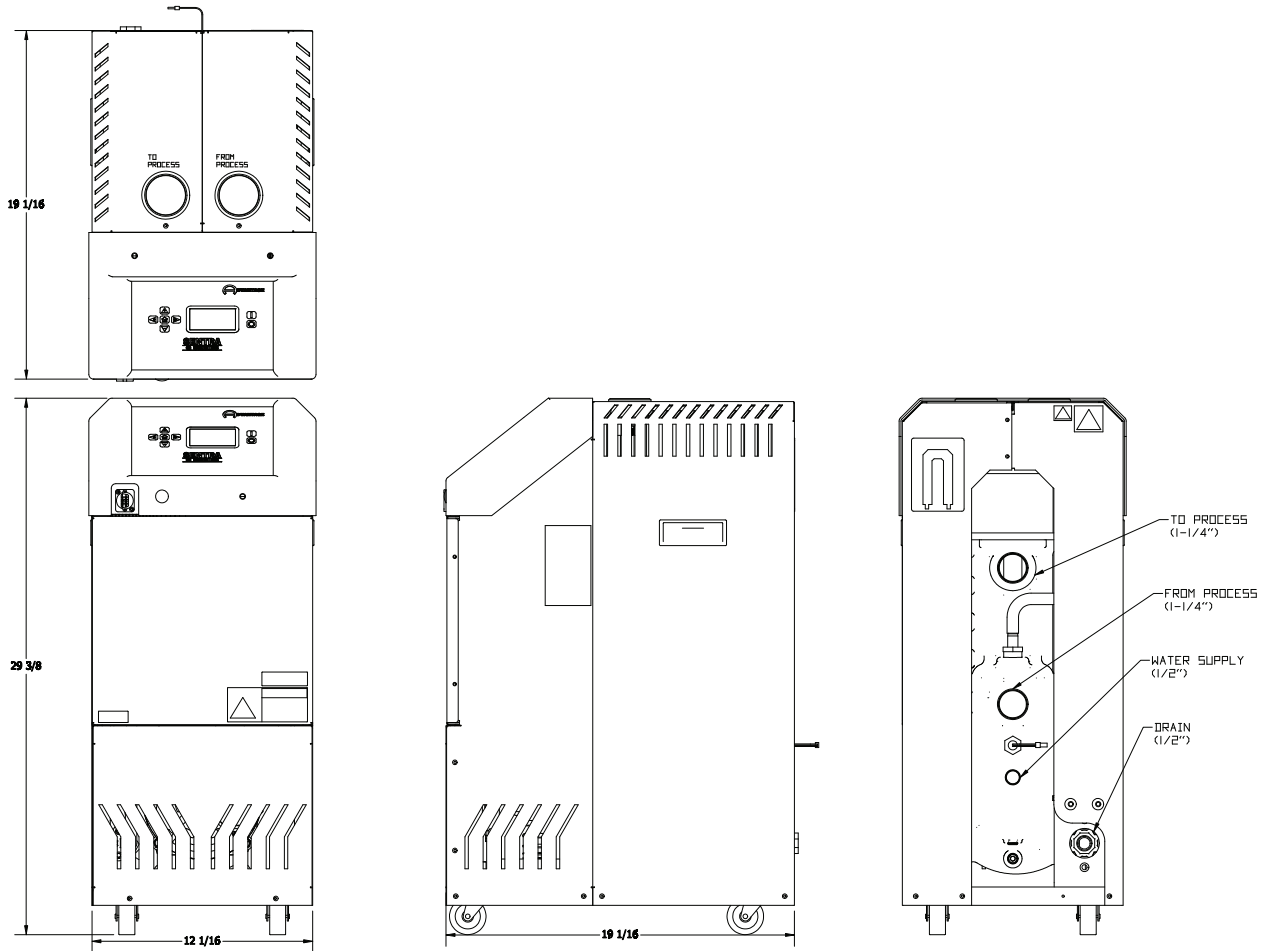

7.2 PHYSICAL : Cabinet Style for Units with: 24 & 34 kW Heaters and Pumps to 3 HP

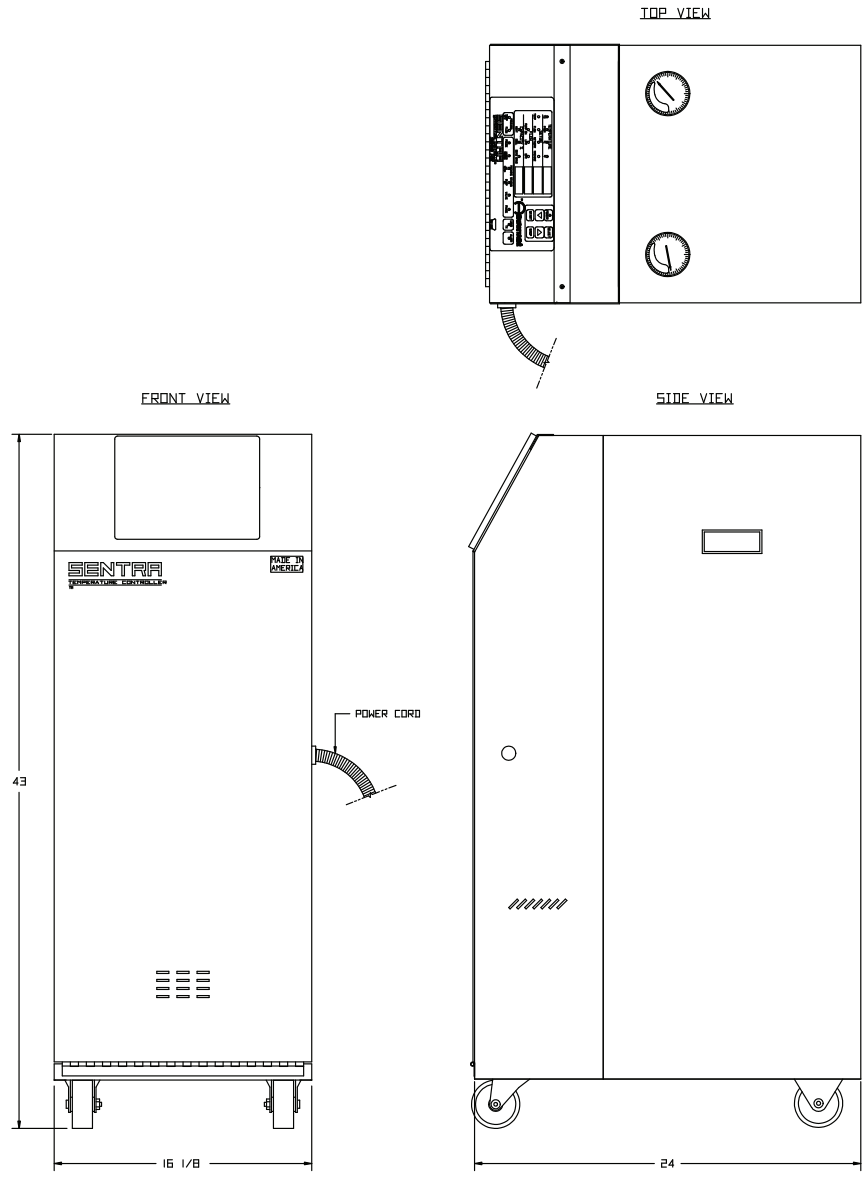

Provided for display purposes only. Refer to electrical drawing supplied with unit for details.



7.3 PHYSICAL : Cabinet Style for Units with : 5 & 7½ HP Pumps

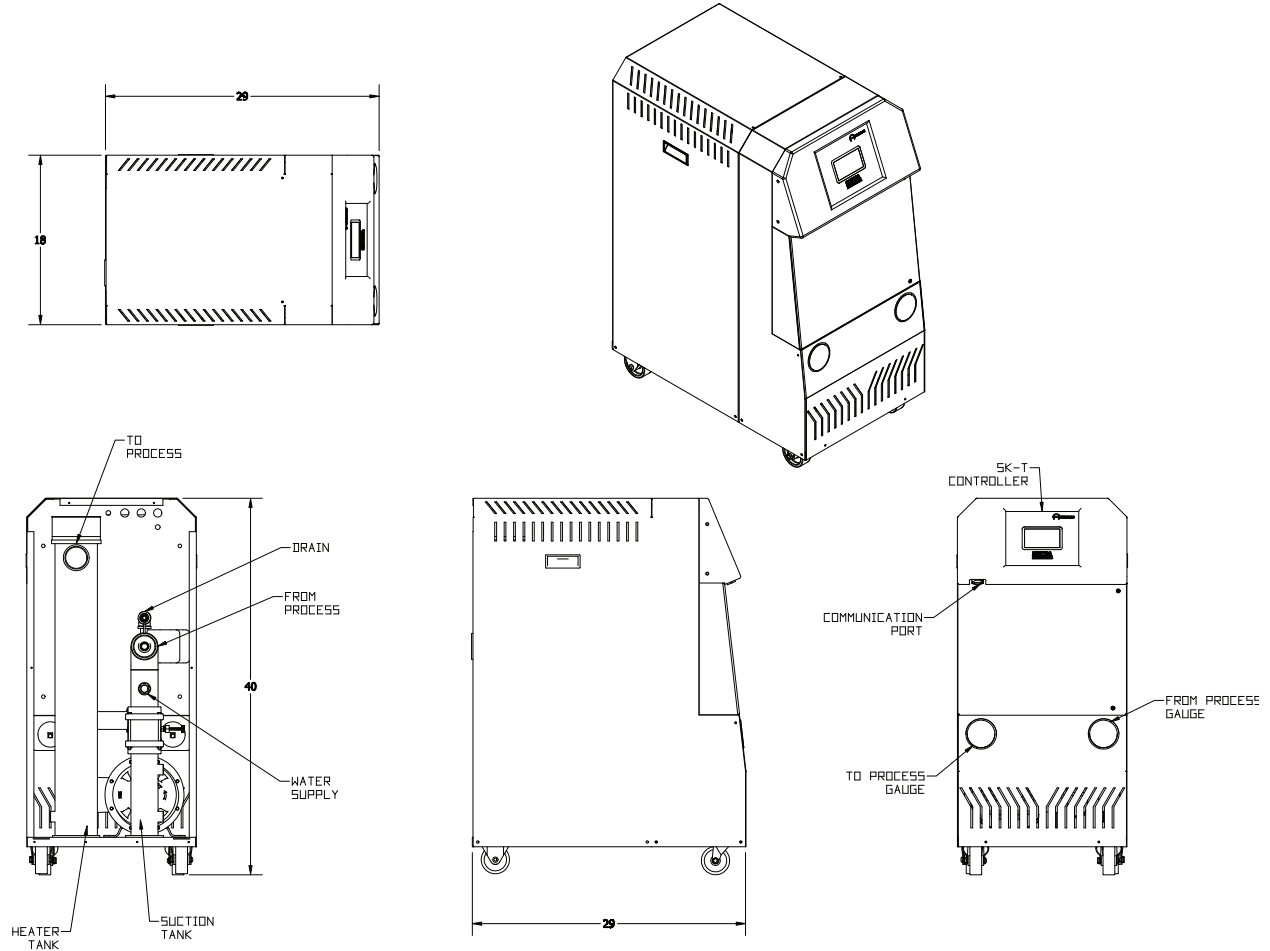

7.4 REGULATOR/BYPASS INSTALLATION

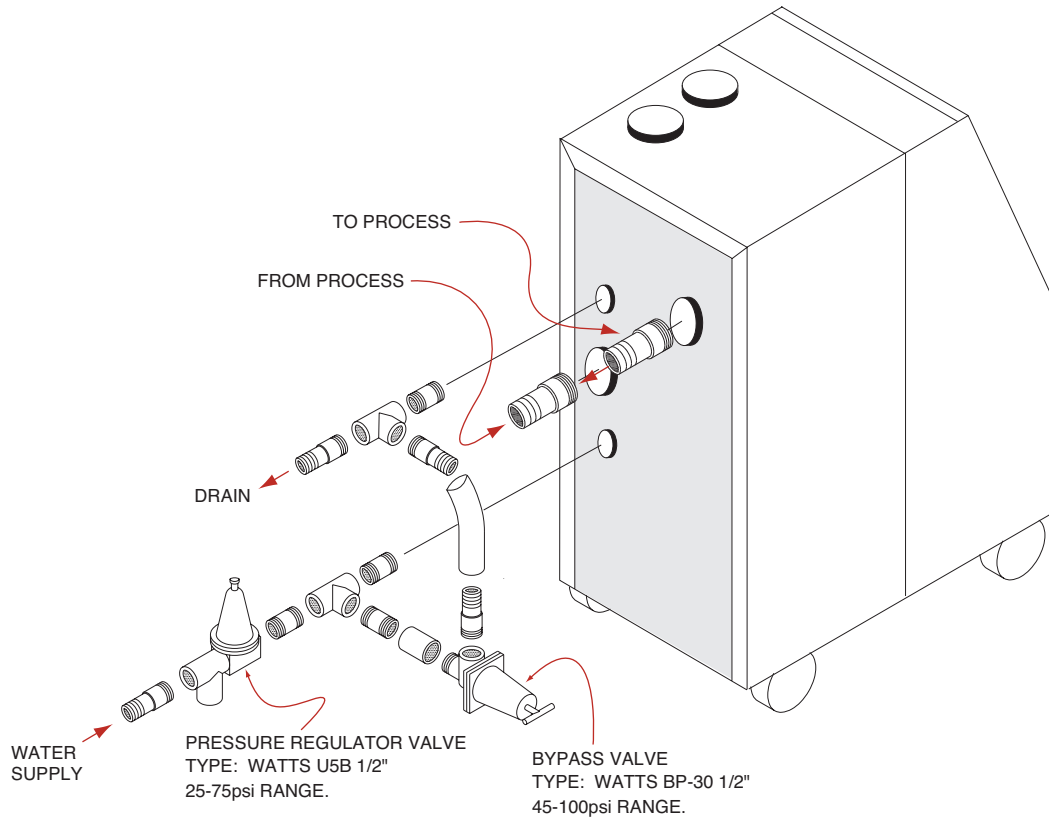

7.5 DUAL ZONE DOLLY



Molders often need to run different temperatures on each mold half to produce the best quality part.

The Manufacturer can provide a dual zone dolly that holds two standard single zone temperature control units to meet this need.

The dual zone dolly provides the convenience of a dual zone configuration while providing the economic first cost and ease of maintenance associated with independent single zone units.

Options:

- Single cooling water supply and drain connection
- Single power supply connections

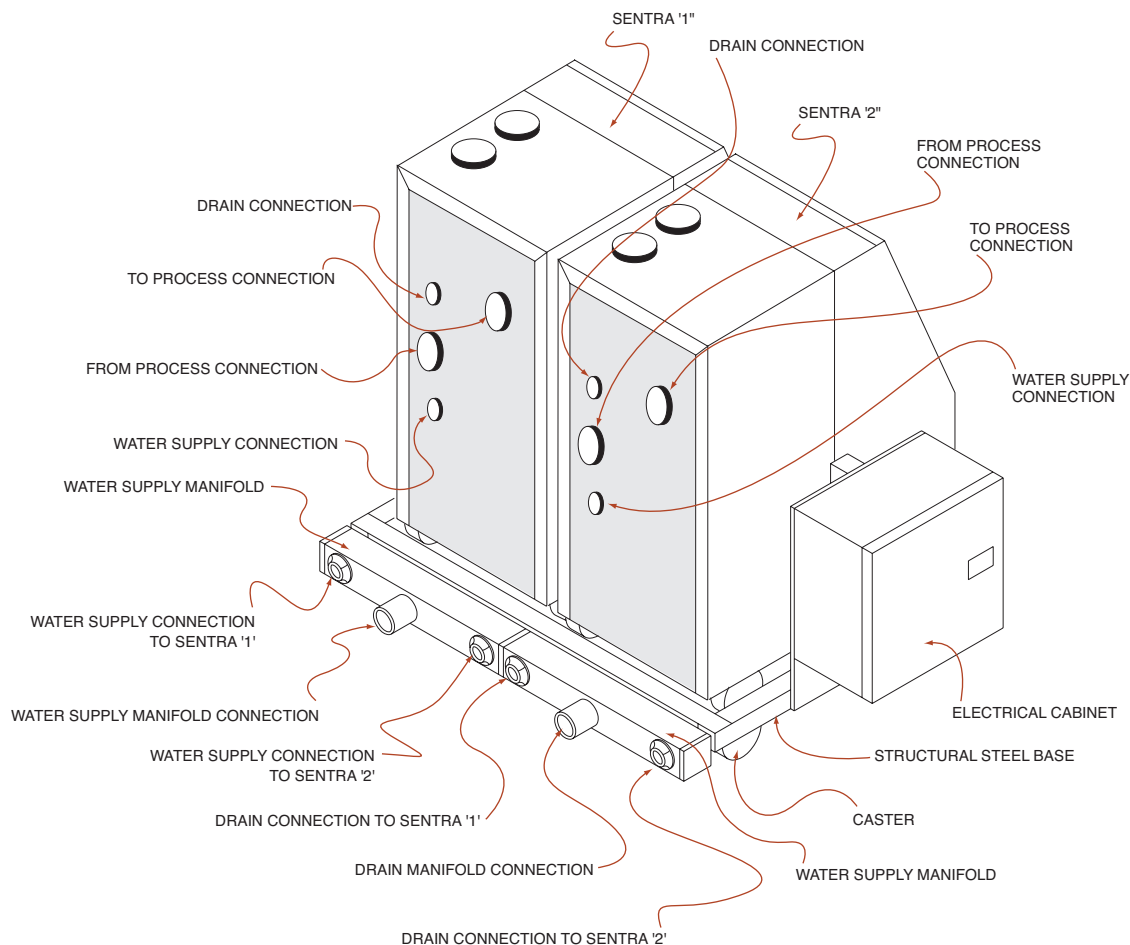

7.6 STACKING RACK

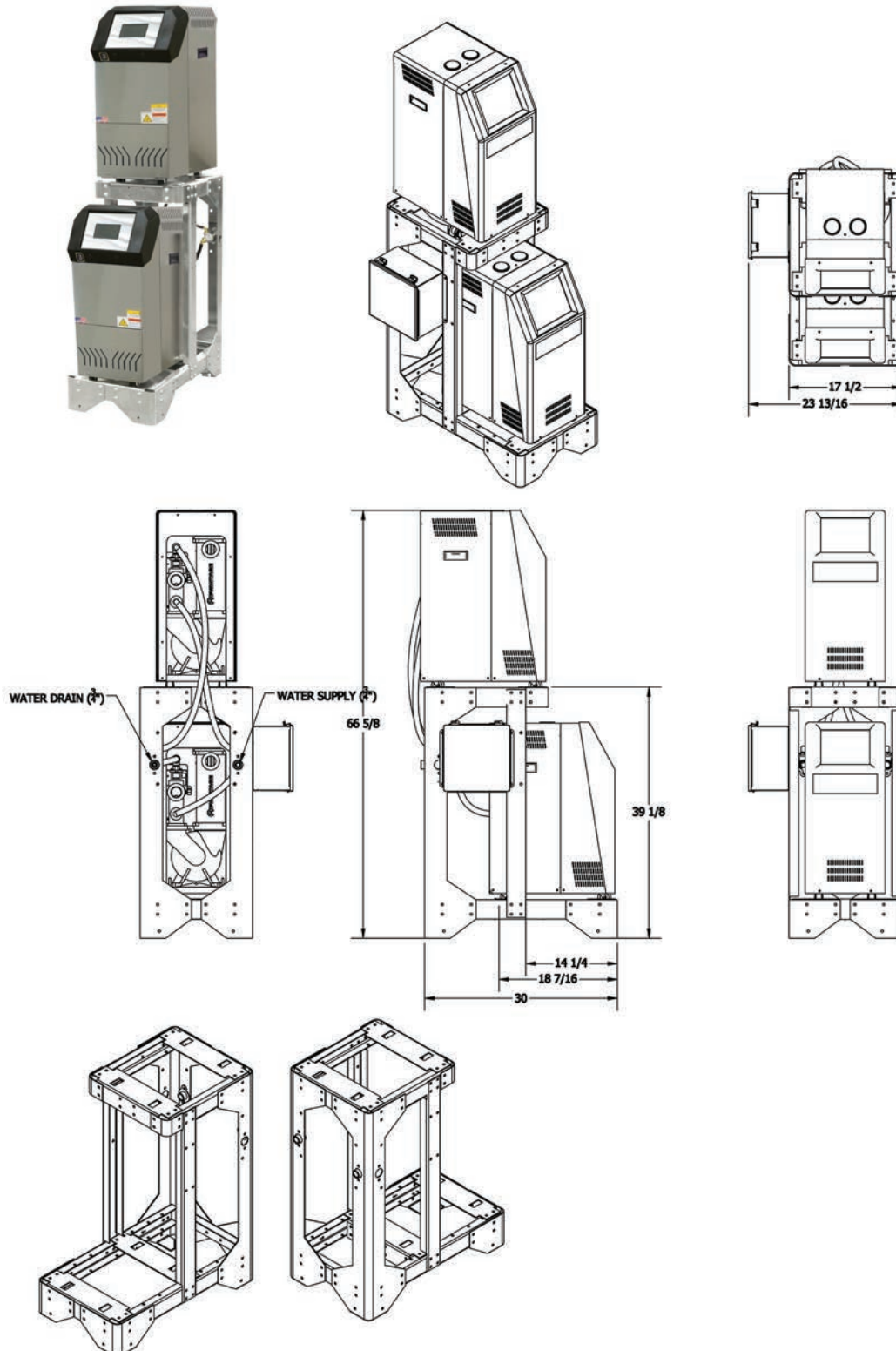

THIS PAGE INTENTIONALLY BLANK

8.0 APPENDIX

- 8.1** Model Number & Suffix Coding
- 8.2** Interpretation of Process Pressure Gauges
- 8.3** Operation of Mold Purge
- 8.4** Remote and Autostart Feature Configuration
- 8.5** SPI Commands
- 8.6** Communication Cable
- 8.7** Optional Alarm Operation
- 8.8** Standard G English Factory Default Settings
- 8.9** Parts : #119 Pump



8.1 MODEL NUMBER & SUFFIX CODING

The data tag on your Temperature Control Unit provides general information about the unit. Compare the information below with your data tag for more information about your unit. Some data tags may have other or different information. If you need specific information about the configuration of your unit contact the factory with the serial number from your unit.

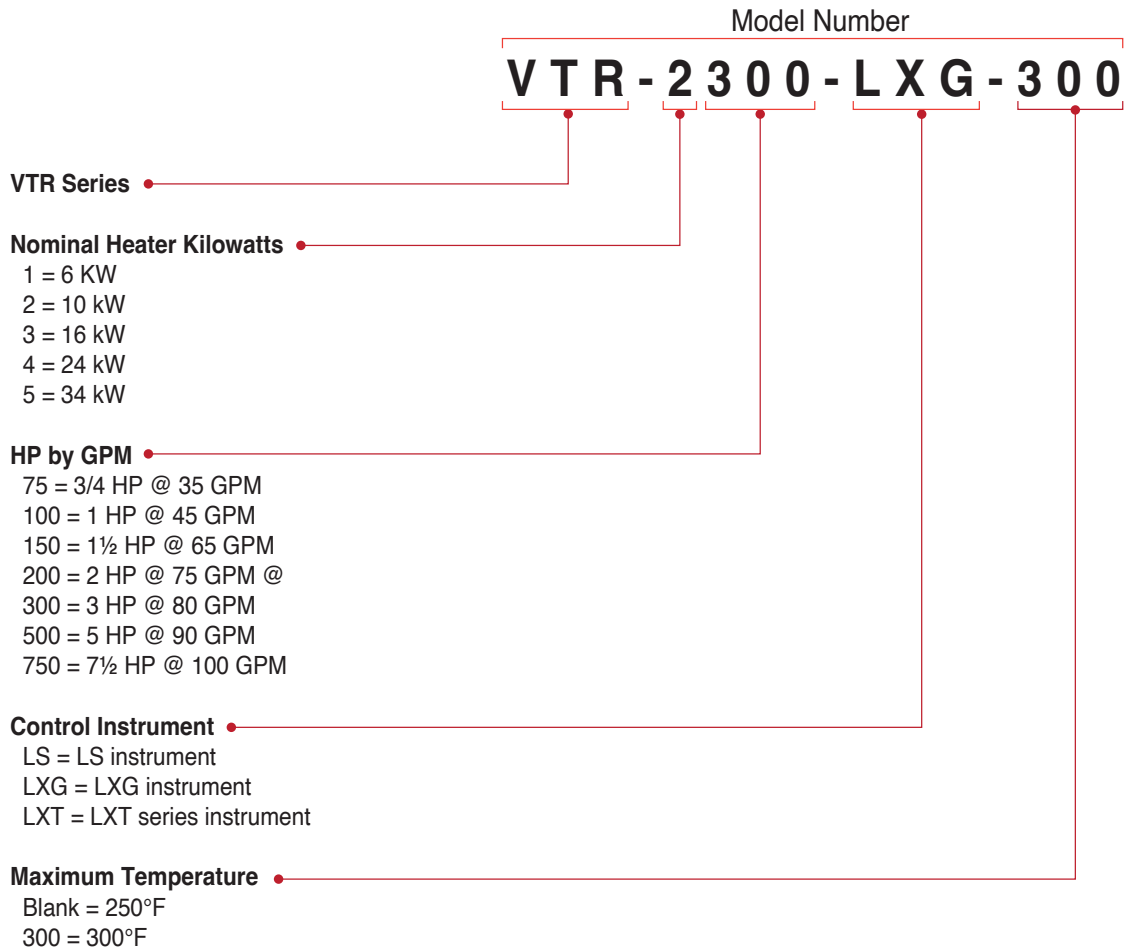

8.2 INTERPRETATION OF PROCESS PRESSURE GAUGES

A. READ AVAILABLE WATER PRESSURE AT UNIT'S LOCATION. When a temperature control unit is attached to the process with the water supply on and the pump off, both gauges will read the water supply pressure at the unit's location.

B. READ PRESSURE DROP ACROSS PROCESS (ΔP).

With the pump on, the "to process" pressure gauge will rise to read the sum of the water supply pressure and pump generated pressure. The "from process" pressure gauge reads the effect of water supply pressure and pump suction pressure. The difference between the to and from process gauges is the pump generated circulating pressure... which is also equal to the pressure drop across the process.



Pressure gauges

C. PUMP ROTATION INDICATION. If the pump is running, and both gauges are "close" to same value, it is likely that the pump is rotating backward, or the pump is generating such a high flow that an overload condition will result.

D. PUMP MOTOR OVERLOAD CONDITION. If the ΔP is low with the pump rotating correctly, then the flow rate is high, which probably will result in a motor overload. Refer to the representative pump curve below.

E. WATER HAMMER (COMPETITIVE SOLENOID VALVE UNITS). On competitive mold temperature controllers, when ΔP gauges are supplied, the water hammer effect of on/off solenoid valves can be seen. When the solenoid valve is open, both to and from process pressure gauges will fall as the system depressurizes. When the valve closes, there will be a momentary spike that will be seen on both pressure gauges, then they will settle back to normal ΔP values. This spike is called "water hammer".

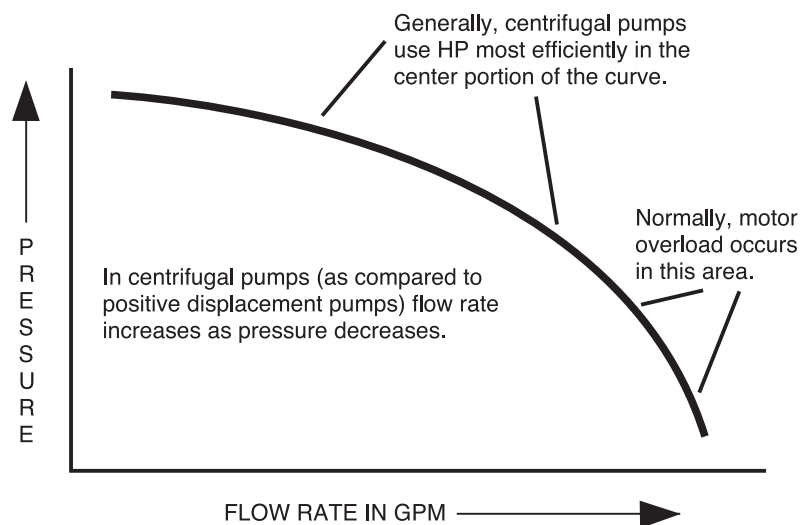

8.3 OPERATION OF MOLD PURGE

- A. The mold purge system includes valves and piping that when activated and supplied with compressed air will expel process water from the mold or process to the central water return line or drain.
- B. Mold Purge is an optional feature and not included on all units. The function of the Mold Purge requires the purchase on the option.
- C. The Mold Purge parameter must be enabled to operate the mold purge. Advance to the Main Menu and select Options. Within the Options menu, select Mold Purge. Select Enable to enable the Mold purge system. Press the Select button to acknowledge and save the selection.

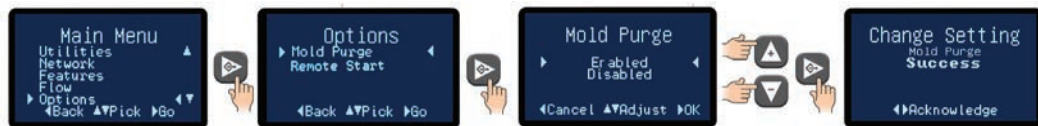

- D. **The mold purge feature is used when the pump is turned off and has been cooled to below 85°F.**
- E. The operation of the mold purge is as follows (see illustration) :

1. Stop the pump, maintain electrical power to unit.
2. Close the water supply ball valve.
3. Connect a regulated air supply to mold purge compressed air connection.

Note: Air supply should be regulated approximately 10 PSI above drain line pressure.

4. Mold Purge is activated by selecting the mold purge item from the Utilities menu. Mold purge is started immediately.

If the pump is running, the follow message will be displayed.



If the pump is not running, the mold purge will start.





ALERT: The Purge cycle must be started and stopped. If not stopped, the Purge cycle will continue and will consume compressed air until stopped.



WARNING: Use caution when disconnecting process lines because residual pressure will remain in the lines. The remaining pressure will be equal to the compressed air pressure used for the purge process. Use caution because disconnecting process lines under pressure incorrectly may cause injury.

5. Press the Stop or Back button to disengage the purge cycle.
6. When water is purged disconnect air supply. The unit can be disconnected at this time as most of the process fluid should be out of the process lines.

AIR AND WATER MOVEMENT DURING MOLD PURGE OPERATION

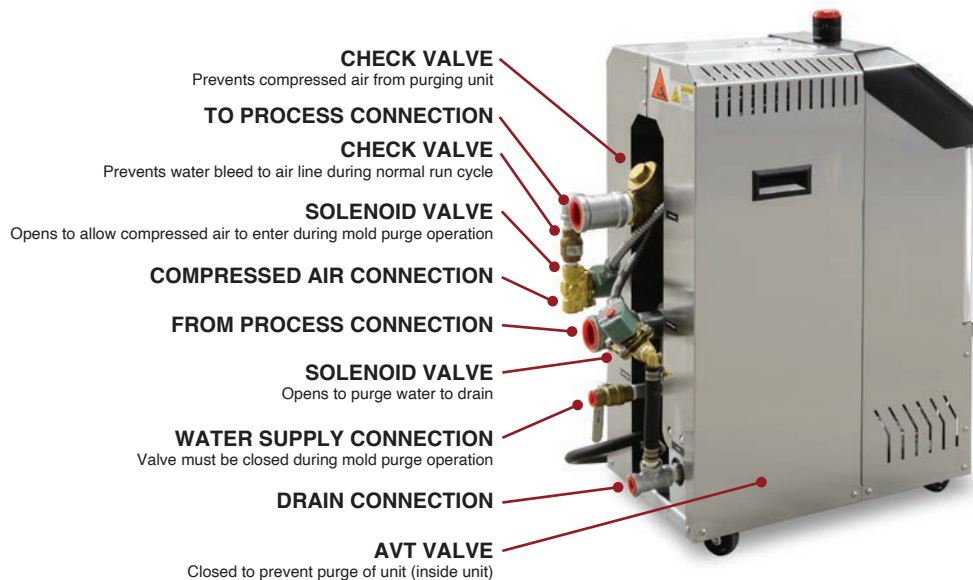
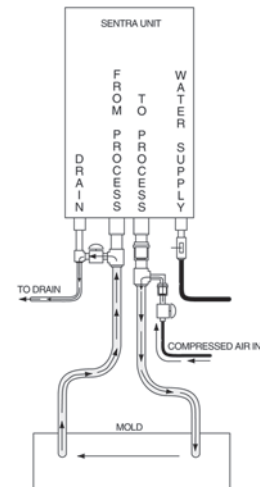

Typical mold purge equipment configuration.

8.4 REMOTE AND AUTOSTART FEATURE CONFIGURATION

- A. Because the on/off button on the unit is a momentary switch, the standard design of the Sentra with G-Series control instrument requires the unit to be manually started and manually restarted if the unit was running and power is interrupted.
- B. The on/off button is a momentary switch. Some users want their unit to start automatically after an interruption in power, referred to as AutoStart in this section. Some users want the unit to be started remotely by a user supplied on/off signal, referred to as Remote Start in this section. The unit may be configured at the factory to include this option or it can be configured in the field.
- C. When factory configured with the AutoStart option described here a second on/off operator will be installed at the factory. When this switch is in the “on” position the AutoStart option is enabled and when a power interruption is experienced the unit will turn off. When power is restored the unit will restart. When this switch is in the off position and power is lost and restored the unit will not AutoStart. The soft touch on/off operator on the control panel will also turn the unit on and off. The operator that is last used will control the unit’s operation.
- D. When factory configured with the Remote Start option described here the second operator described in 8.4.c is not included. The customer supplied Remote Start/Stop signal turns the unit on and off. The soft touch on/off operator on the control panel will also turn the unit on and off. The operator that is last used will control the unit’s operation so the unit can be started either at the machine by using the control panel on/off operator or remotely with the customer supplied signal. A terminal connection is provided in the electrical panel.
- E. **Field installed AutoStart option:**
 - 1. Add a manual on/off operator to the unit.
 - 2. Wire to the Remote start / AutoStart contacts on the control board (see picture).
 - 3. Place manual on/off switch in the on position to activate AutoStart.
 - 4. Follow the instructions in 8.4.G to enable the AutoStart option on the control panel.

Remote Start Contacts

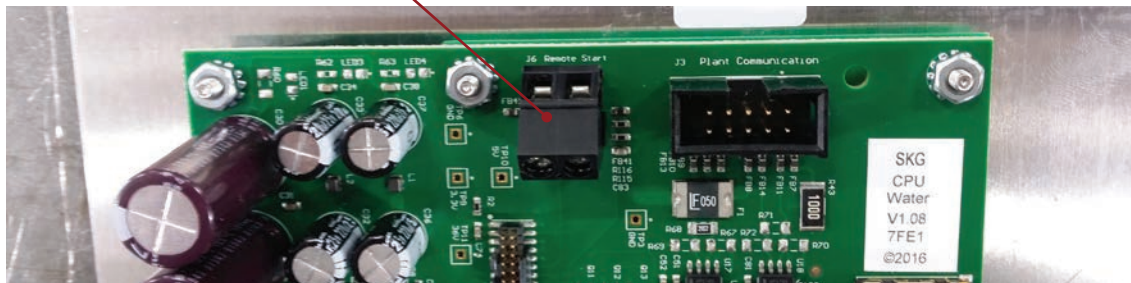

F. Field installed Remote Start Option

1. Wire user supplied dry contact closure wiring to the contacts provided on the board (see picture). A relay is recommended.
2. Follow the instructions in 8.4.G to activate Remote Start option on the control panel.

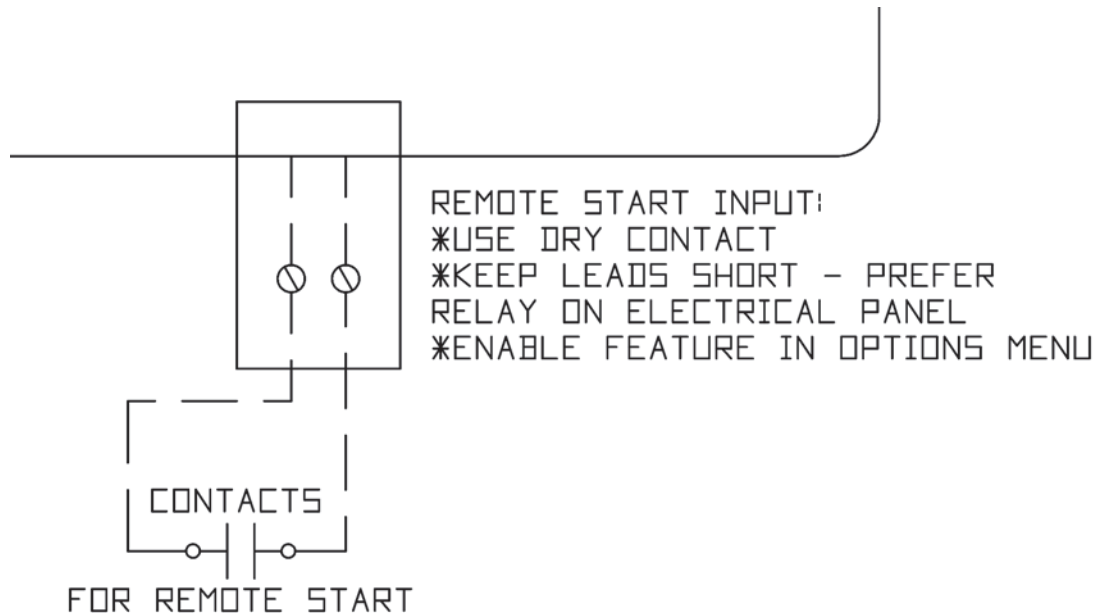

G. To enable the AutoStart and or Remote Start options

1. Access main menu and advance to the Options menu.
2. From the Options menu, select Remote Start.
3. Press the select button to advance to the enable/disable screen.
4. Select Enabled to enable the Remote Start or AutoStart option
5. Press the Select button to acknowledge and save the selection.

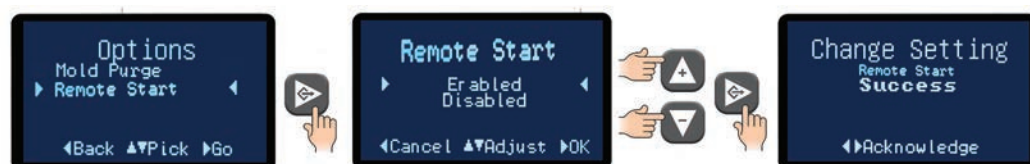

8.5 SPI COMMANDS

- A. INTRODUCTION:** In 1987 a group of member companies of the Society of the Plastics Industries began development of a communication protocol for use by their processing and auxiliary equipment. Their goal was to allow the exchange of information between various pieces of equipment from different manufacturers to be simple and reliable. The result of their work was released in 1990 and has made the interconnection of equipment much easier and straightforward. There are now over 40 companies that offer the SPI Protocol in their products. This document details the implementation of the SPI Protocol available in the SENTRA 'SK' temperature controllers and MAXIMUM 'MK' portable chillers with HE instruments.
- B. PROTOCOL BASICS:** The SPI Protocol is described by a 2 part specification. The largest portion of the SPI Protocol specification deals with how basic information is exchanged between equipment. The second part of the specification details the actual pieces of information exchanged using the protocol. Items such as Process Temperature, Process Setpoint and Process Status are detailed in this part. This FYI will list the commands that are supported by this equipment.
- C. EQUIPMENT SETUP:** The setup of equipment to be connected in an SPI Protocol network is simple. Each device must have a unique address for its device type and it must use the same data transfer rate as the other pieces of equipment in the network. There are many acceptable ways used to 'set' the device address and data rate. This equipment provides access to the information via the front panel operators and displays. Other manufacturers may use internal DIP switches or jumpers.

A typical cell may be configured as follows:

Data Transfer Rate: 9600 bits per second (bps)
Mold Temperature Controller (Qty 2): Addresses 1 and 2
Chiller (Qty 1): Address 1

Note in the above example that different device types may have the same address. This is because the SPI Protocol uses the device type as part of its internal address.

- D. NETWORK TROUBLESHOOTING:** Troubleshooting a network is best done by verifying the setup of each piece of equipment and insuring that the network is installed with the correct electrical interconnection. Here are some basic things to do if equipment isn't 'talking' as expected.
1. Verify that each piece of equipment is properly grounded to its power source.
 2. Inspect cables inside and outside the electrical cabinet. Repair or replace as necessary. The cable scheme used by most manufacturers allows the communication signals to 'pass through' each piece of equipment. Therefore, when a piece of equipment is disconnected from the middle of the network, all the equipment 'after' that one will be disconnected, too. If a piece of equipment is being permanently removed, the device cables should be rearranged at the molding machine to reconnect the other equipment.



3. Check the Data Transfer Rate and Address of each piece of equipment. For example, if both Temperature Controllers have the same address, they will both try to 'talk' at the same time and garble each other's data.
4. Verify the network is properly terminated and that it is configured as a 'multi-drop'. This is best achieved by following the molding machine manufacturer's installation instructions and use extension cables provided by them or us.
5. Attach each device, singly, to the molding machine and see if it 'talks'. Add additional devices until a problem is seen.

SENTRA 'SK' Temperature CONTROLLER SPI COMMANDS

POLL		SELECT		COMMAND	DESCRIPTION
C1	C2	C1	C2		
20	20	20	21	Echo	Controller integrity command
20	20			Version	Controller version command
20	30	20	31	Setpoint	Desired process temperature
20	32	20	33	High temp	Hi temperature deviation alarm
20	34	20	35	Low temp	Low temperature deviation alarm
20	36	20	37	Flow Alarm	Low flow alarm setpoint*
20	40			Status Process	

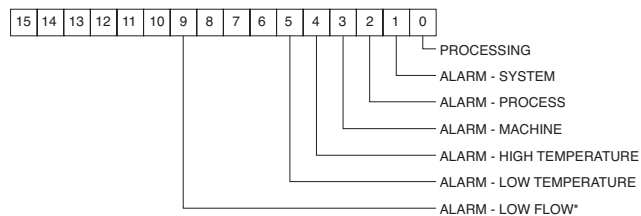

POLL		SELECT		COMMAND	DESCRIPTION
C1	C2	C1	C2		
20	42			Status Machine 1	

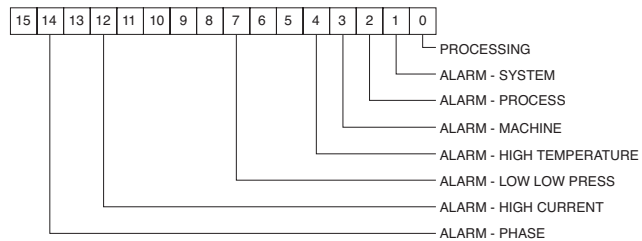

POLL		SELECT		COMMAND	DESCRIPTION
C1	C2	C1	C2		
20	44			Status Machine 2	

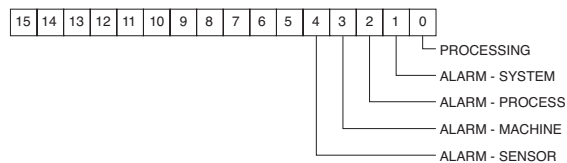

POLL		SELECT		COMMAND	DESCRIPTION
C1	C2	C1	C2		
20	48	20	49	Machine	

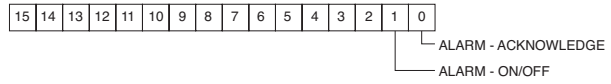

POLL		SELECT		COMMAND	DESCRIPTION
C1	C2	C1	C2		
20	4A	20	4B	Protected mode - machine	

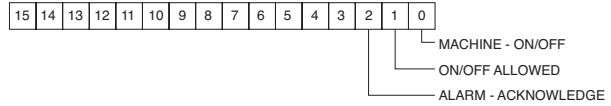

POLL		SELECT		COMMAND	DESCRIPTION
C1	C2	C1	C2		

- | | | |
|-------|----------|------------------------------|
| 20 70 | | Temperature to process |
| 20 72 | | Temperature from process* |
| 20 78 | | Flow rate from unit GPM* |
| 20 E0 | | Blanket Poll |
| | Returns: | 20 30 Setpoint |
| | | 20 32 High alarm deviation |
| | | 20 34 Low alarm deviation |
| | | 20 40 Status process |
| | | 20 70 To process temperature |

8.6 COMMUNICATIONS CABLE

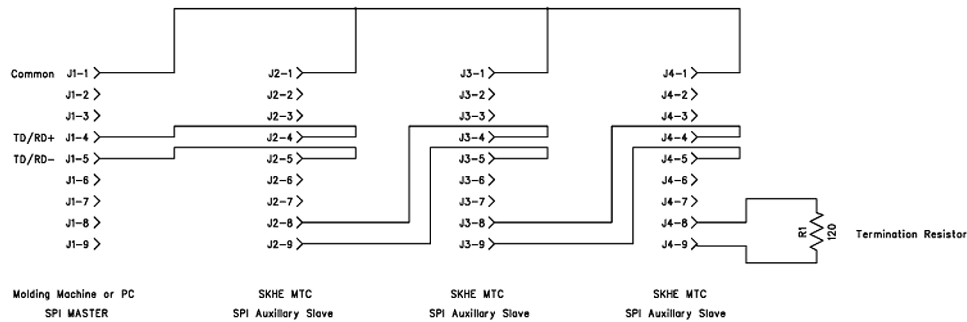

Machine Connections Primary Machine Connections

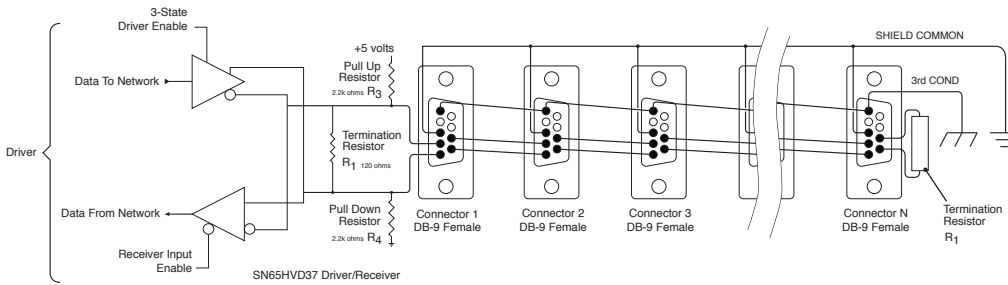

Figure 8.5B

Auxiliary Machine Connections

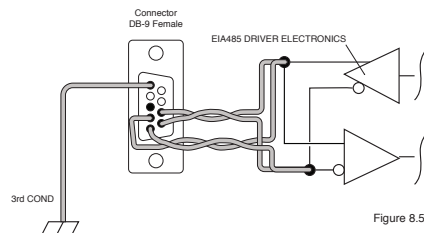

Figure 8.5C

Jumper Plug

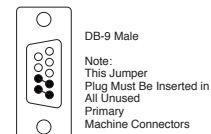

Figure 8.5D

8.7 OPTIONAL ALARM OPERATION

- A. The Temptender and G Series instruments are standard with a 110 volt AC alarm output. The alarm output can be connected to customer provided alarm annunciation, plant-wide monitoring system or optional annunciation provided by the factory.
- B. Beacon Alarms used when both visual and audible alarm annunciation is needed. The beacon is an integral light and buzzer assembly to provide high visibility in a busy, noisy shop. The beacon will signal until the alarm condition is acknowledged by the operator.
- C. Audible alarms provide a loud signal when an alarm condition is present. The audible alarm is mounted on the front cover of the unit.

CONDITIONS THAT TRIGGER AN ALARM OUTPUT ON MOLD TEMPERATURE CONTROLLERS

CONDITION	CONTROLLER	
	T	G
Incorrect 3Ø power entry	Yes	No
Pump overload tripped	Yes	Yes
High temperature fault	Yes	Yes
Water supply pressure fault	Yes	Yes
Temperature deviation	Yes	Yes
AVT valve malfunction	Yes	Yes
Sensor probe malfunction	Yes	Yes

**BEACON AND AUDIBLE ALARMS ARE SILENCED
DURING AN ALARM CONDITION BY PRESSING
THE START BUTTON ON MICROPROCESSOR
CONTROLLER**

8.8 STANDARD G ENGLISH FACTORY DEFAULT SETTINGS

Set Points

Temperature Set Point	100°F
Hi Deviation	10°F
Low Deviation	10°F
Low Flow	0 GPM

Network

Protocol	SPI
Baud Rate	9600
Address	1

Features

Auto Vent Time	45 Seconds
Auto Vent Temperature	100°F
Pump Seal Cooling	Disabled
Pump Seal Cooling Time	60 Seconds
Pump Seal Cooling Temperature	100°F

Flow

Flow	Disabled
Flow Offset	-3 GPM
Flow Calibration	770

Options

Mold Purge	Disabled
Remote Start-Stop	Enabled

Machine

Cooling Valve Size : 1/2"	500:1
Cooling Valve Size : 3/4"	1000:1
Max Set Point	250°F
Units	English
Heat Only Mode	Disabled



8.9 PARTS : #119 PUMP

#119 Pump, Standard 1/2-3 horsepower. Contact the factory for other pump horsepower and custom units.

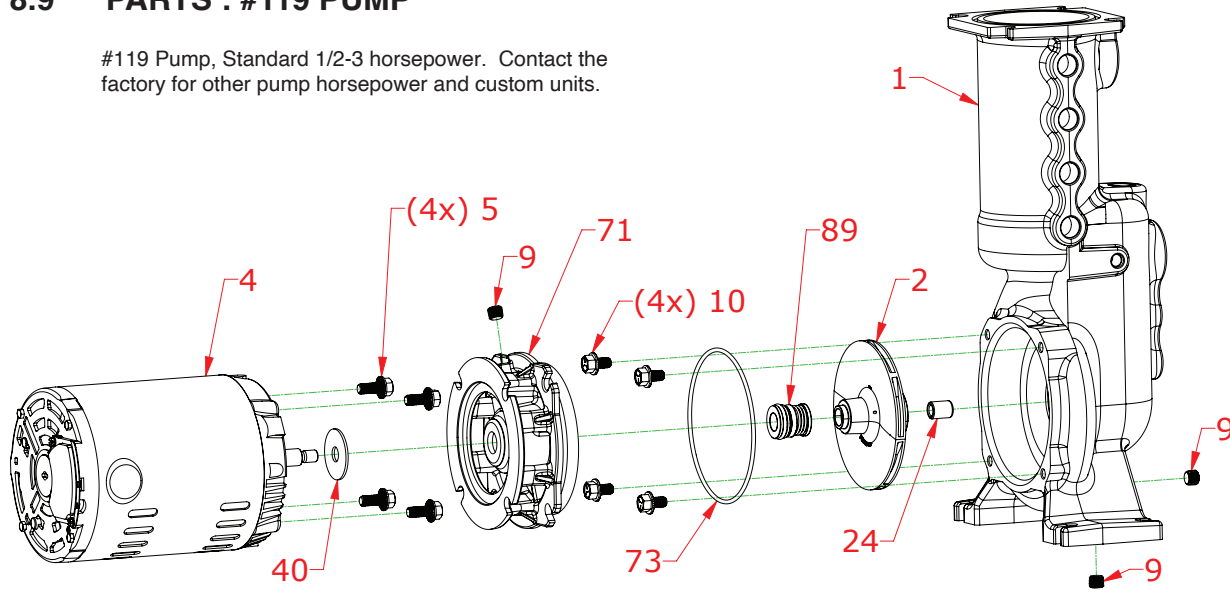

Model 119, 119S 0.5-3.0HP

Key	Description	Part #	Reference #
1	Case 119, Iron, 1.25x1.25 with Integral Tanks	771640	3301304X
	Case 119S, SS304, 1.25 x 1.25 with Integral Tanks	771641	3301308X
2	Impeller 503, Composite, 4.18", 0.5HP	4310560	3301381
	Impeller 503, Composite, 4.34", 0.75HP	4310561	3301382
	Impeller 503, Composite, 4.50" 1.0HP	4310562	3301383
	Impeller 503, Composite, 4.81", 1.5HP	4310563	3301384
	Impeller 503, Composite, 5.06", 2.0HP	4310564	3301385
	Impeller 503, Composite,, 5.31", 3.0HP	4310565	3301386
4	Motor, J56 0.5HP, ODP, 3/60/208-230/460V	4713398	113.000.366W
	Motor, J56 0.75HP, ODP, 3/60/208-230/460V	4713400	113.000.354W
	Motor, J56 1.0HP, ODP, 3/60/208-230/460V	4713401	113.000.372W
	Motor, J56 1.5HP, ODP, 3/60/208-230/460V	4713402	113.000.360W
	Motor, J56 2.0HP, ODP, 3/60/208-230/460V	4713403	113.000.349W
	Motor, J56 3.0HP, ODP, 3/60/208-230/460V	4713404	113.000.368W
5	Bolt, Hex, Adapter to motor, Zinc Steel		137.001.170
	Bolt, Hex, Adapter to motor, SS304		137.003.149
9	Pipe Plug, Hex, Brass		106.000.284
	Pipe Plug, Hex, SS304		108.000.126
10	Bolt, Hex, Adapter to case, Zinc Steel		137.003.070
	Bolt, Hex, Adapter to case, SS304		137.003.150
24	Lock Nut, Stainless	5404005	110.000.190
40	Flinger, Neoprene	7160000	104.000.171
71	Adapter, Iron, J56, 5/8" Seal, with Brass pluts	470	3301001X
	Adapter, SS304, J56, 5/8" Seal, with SS plugs	471	3301135X
73	Gasket, Case, Buna	3444445	137.003.072
89	Pump Seal Ceramic #50458 (for 250°F units)	6491000	
	Pump Seal EPT 101-104 5/8" (for 300° units)	6495315	

END

© 2023 Temptek, Inc.

RE 20230502

