

I.O.M. #093 12/06 updated 02/13

INSTRUCTION MANUAL • INSTALLATION • OPERATION • MAINTENANCE

VETERAN

WATER TEMPERATURE CONTROLLER



Models with 'LX' Series Instrument.



TEMPTEK, INC.
525 East Stop 18 Road Greenwood, IN 46142
317-887-0729 fax: 317-881-1277
Service Department fax: 317-885-8683
www.TempTek.com
e-mail: sales@TempTek.com

VETERAN

WATER TEMPERATURE CONTROLLER

INSTRUCTION MANUAL **VETERAN TEMPERATURE CONTROL UNIT** **with 'LX' SERIES INSTRUMENT**

COVERING

INSTALLATION **OPERATION** **MAINTENANCE**



TEMPTEK, INC. 525 East Stop 18 Road Greenwood, IN 46142
317-887-0729 fax: 317-881-1277 Service Department fax: 317-885-8683
www.TempTek.com e-mail: sales@TempTek.com

TABLE OF CONTENTS

QUICK START-UP GUIDE		
QUICK TROUBLESHOOTING GUIDE		7
1.0	GENERAL	9
	1.1 Safety	10
	1.2 Efficiency	10
	1.3 Typical Label Placement	10
	1.4 Component placement	11
2.0	INSTALLATION	13
	2.1 General	14
	2.2 To and from process connections	14
	2.3 Water supply connection	15
	2.4 Drain connection	15
	2.5 Electrical connection	16
3.0	START UP SEQUENCE	19
	3.1 General	20
	3.2 System fill/operations procedure	20
	3.3 Instrument operation	25
	3.4 Shut down/disconnect sequence	32
4.0	TROUBLESHOOTING	35
	4.1 Unit will not start (Power light off)	36
	4.2 Unit will not start (Power light on)	36
	4.3 Unit stops	36
	4.4 Unit overheats	37
	4.5 Unit underheats	38
	4.6 Pressure relief valve leaks	39
	4.7 Cooling valve fault	40
5.0	MAINTENANCE	41
	5.1 Pump seal replacement	42
	5.2 Heating cylinder replacement	45
	5.3 AVT™ cooling valve service	47
	5.4 Probe calibration	51
	5.5 Voltage changeover	53
	5.6 Sensor probe service	56
	5.7 Pressure switch service	58
	5.8 Instrument service	59
	5.9 Configuring temperature display units	61
	5.10 Configuring alarm temperature parameter	62
	5.11 Configuring communications rate	63
	5.12 Electronic Instrument Repair Policy And procedure	64



6.0	COMPONENTS	65
6.1	Mechanical system	66
6.2	Electrical system	67
7.0	RELATED DRAWINGS	69
7.1	Physical	72
7.2	Electrical	73
7.3	Circuit schematic	74
7.4	Regulator/bypass installation	75
7.5	Dual zone dolly	76
7.6	Stacking rack	77
8.0	APPENDIX	79
8.1	Specifications	80
8.2	Model # and suffix coding	81
8.3	Interpretation of process pressure gauges	82
8.4	Mold purge operation	83
8.5	Closed Circuit Operation	84
8.6	SPI commands	85
8.7	Communications Cable	88
8.8	Optional alarm operation	89
8.9	AVT™ Valve Components	90
8.10	AS5 pump parts list - 1/2 HP to 1 HP	91
8.11	AS5 pump parts list - 1 1/2 HP to 3 HP	92
8.12	parts list - LX instrument	93



QUICK START-UP GUIDE

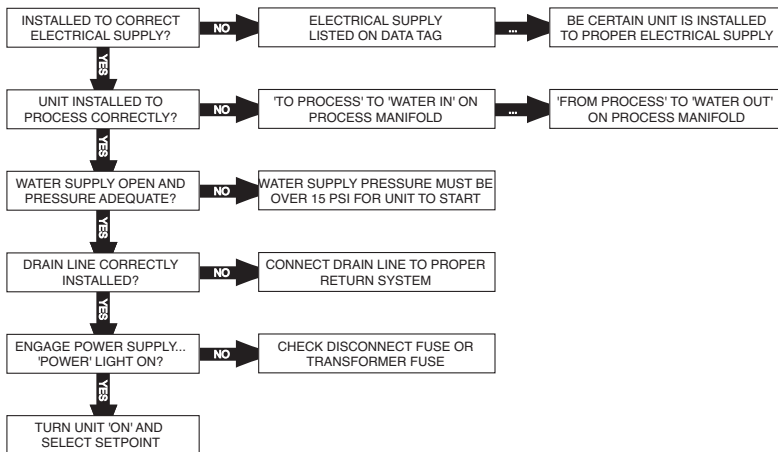

QUICK TROUBLESHOOTING GUIDE

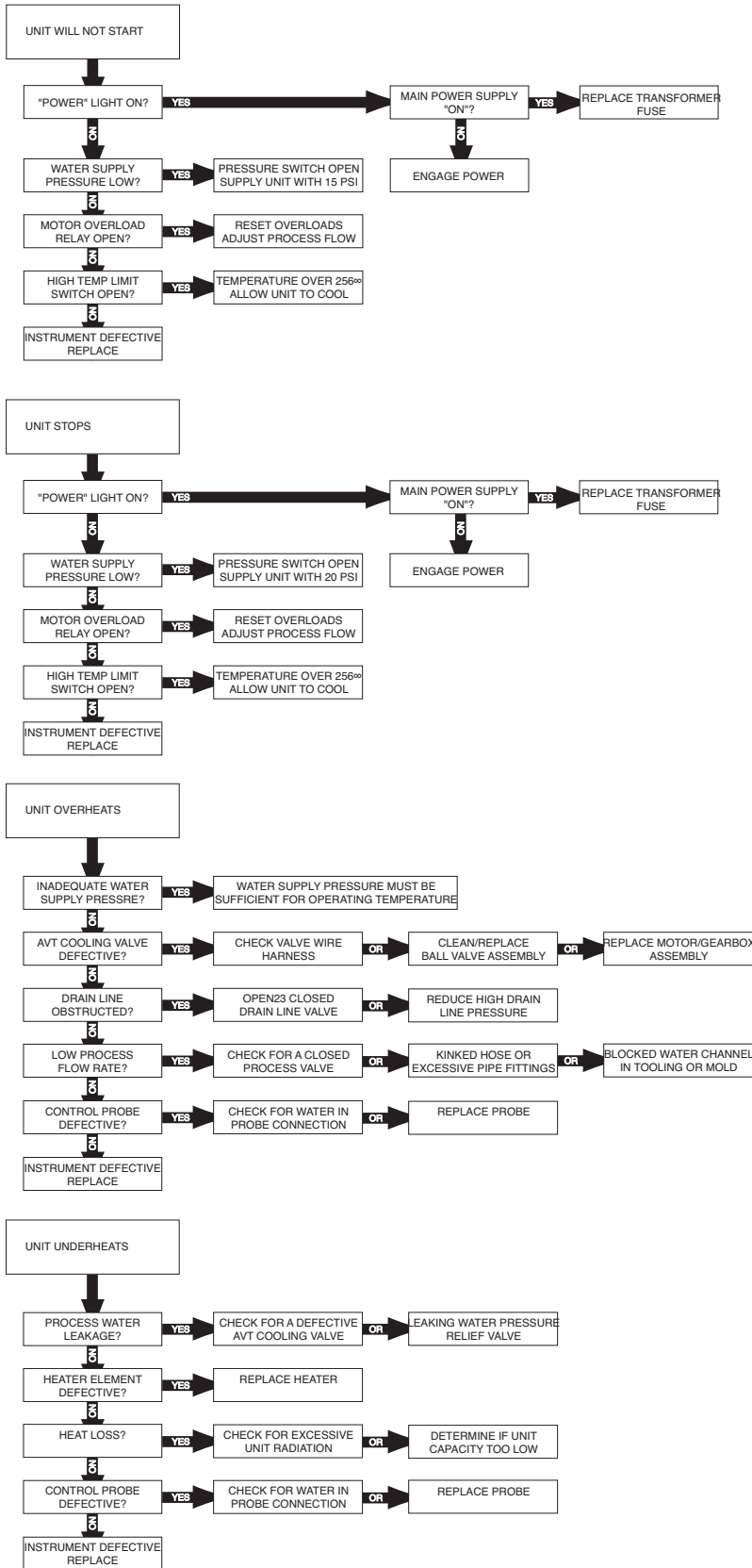

THIS PAGE INTENTIONALLY BLANK

1.0 GENERAL

- 1.1 SAFETY**
- 1.2 EFFICIENCY**
- 1.3 TYPICAL LABEL PLACEMENT**
- 1.4 COMPONENT PLACEMENT**



1.1 SAFETY

- A. It is important to become thoroughly familiar with this manual and the operating characteristics of the equipment.
- B. Several important references are made to safety considerations in this manual. It is the owner's responsibility to assure proper operator training, installation, operation, and maintenance of the water temperature controller with instrument.

1.2 EFFICIENCY

- A. Long term efficiency of operation is largely determined by proper maintenance of the mechanical parts of the unit and water quality. We recommend filtering where required to prevent solids from plugging critical parts such as pumps, heaters and seals. The services of a competent water treatment specialist must be obtained and his recommendations followed. Temptek accepts no responsibility for inefficient operation, damage caused by foreign materials, or failure to use adequate water treatment.

1.3 TYPICAL LABEL PLACEMENT



1.4 COMPONENT PLACEMENT

- A. The temperature controller is designed to circulate temperature stabilized water through the process system to result in process temperature control.
- B. Please note that the ability of the equipment to achieve this objective is significantly affected by the method of installation.
- C. If the operator has any questions, contact the Sales or Service Department at 317-887-0729.

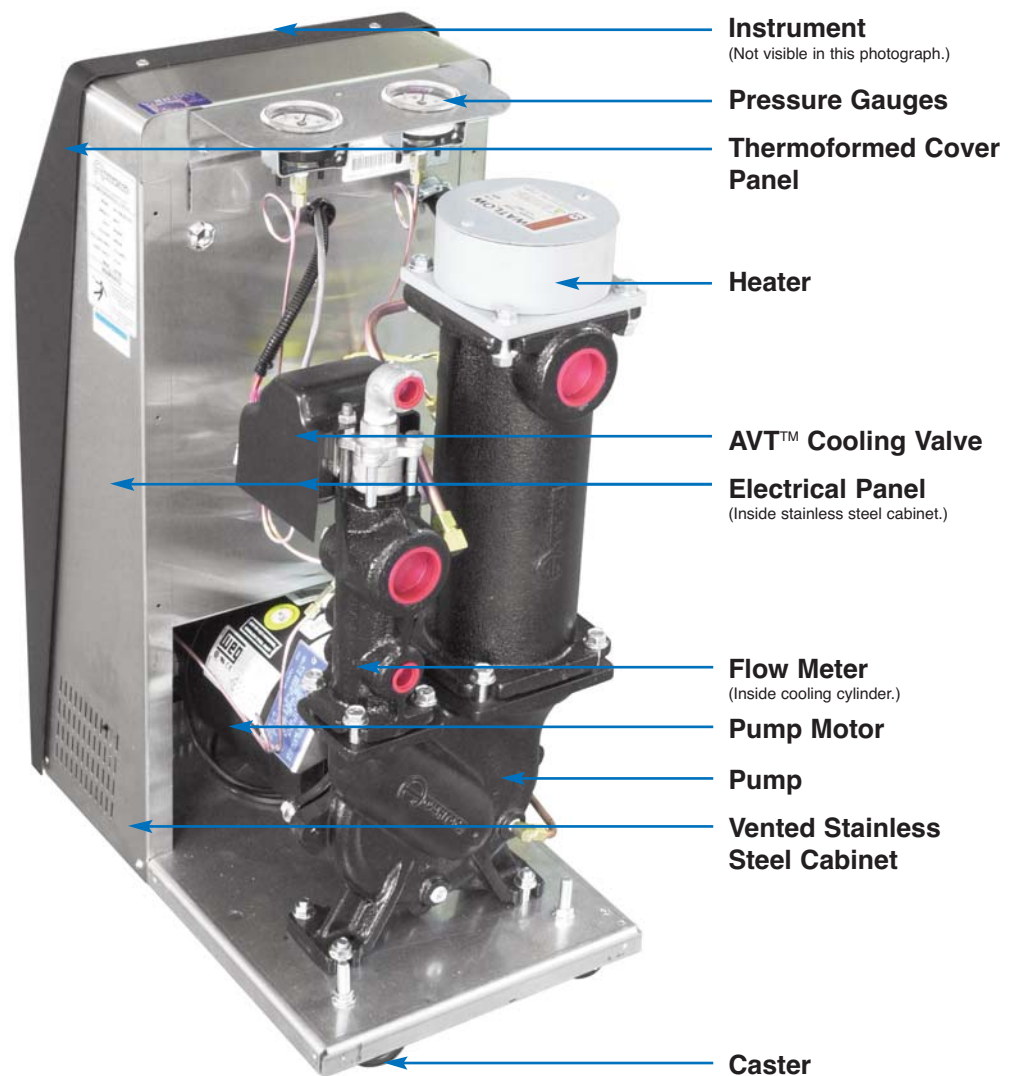



2.0 INSTALLATION

- 2.1 GENERAL**
- 2.2 TO AND FROM PROCESS CONNECTIONS**
- 2.3 WATER SUPPLY CONNECTION**
- 2.4 DRAIN CONNECTION**
- 2.5 ELECTRICAL CONNECTION**



2.1 GENERAL

- A. All process piping materials such as hose, rigid piping, valves or filters, used in process water piping circuitry must be rated for **350°F minimum temperature** and **200 PSI minimum pressure**.
- B. Be certain all process piping materials have the equivalent or larger diameter of the particular process connection.

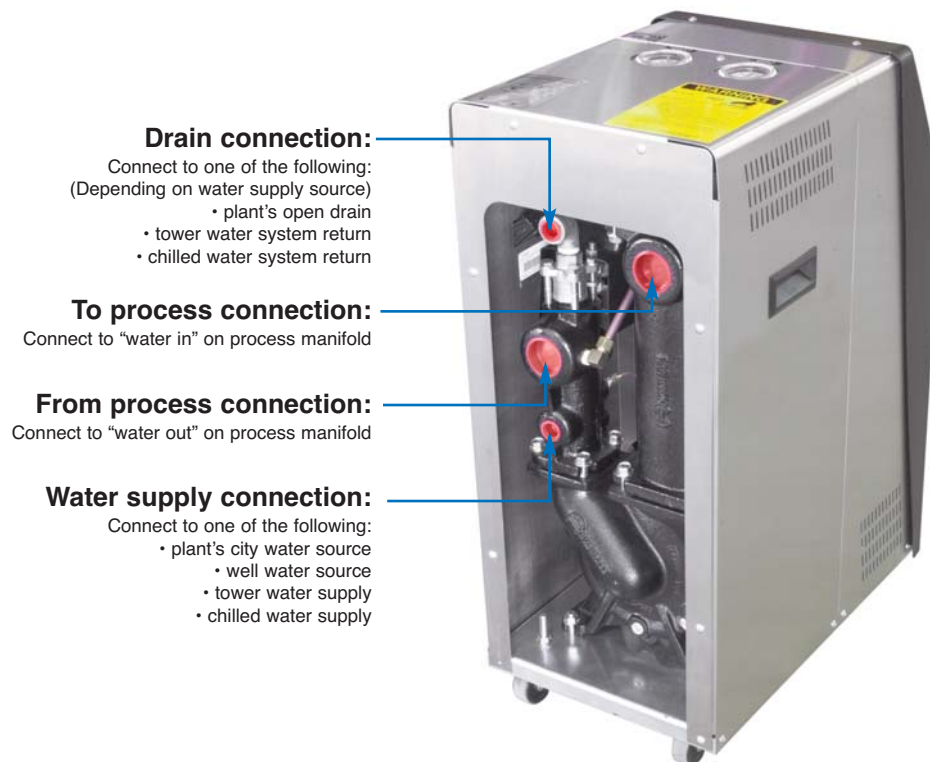

Drain connection:

- Connect to one of the following:
(Depending on water supply source)
- plant's open drain
 - tower water system return
 - chilled water system return

To process connection:

Connect to "water in" on process manifold

From process connection:

Connect to "water out" on process manifold

Water supply connection:

- Connect to one of the following:
- plant's city water source
 - well water source
 - tower water supply
 - chilled water supply

2.2 TO AND FROM PROCESS CONNECTIONS

- A. Connect the unit's *To Process* port to the *Water In* port on the process manifold.
- B. Connect the unit's *From Process* port to the *Water Out* port on the process manifold.
- C. **Please note:** Process water piping circuitry should be designed to avoid an excessive use of elbows and/or lengths of pipe or hose. If hose is the material of choice, avoid tight twists or curls and excessive lengths.
- D. Valves and filters may be installed in the process water piping circuitry to facilitate service and maintenance, provided that such devices maintain the full inside diameter of the process connection. If installed, all such devices must be open and clean during unit operation.

2.3 WATER SUPPLY CONNECTION

- A. Connect the unit's *Water Supply* port to the plant's city water, well water, tower water or chilled water supply.
- B. Water supply pressure requirements vary with operating temperatures. Figure 2.2A shows the required operating water supply pressures for various operating process temperatures. The required water supply pressure retains process water in a liquid state at temperatures over 180°F. Failure to maintain the required water supply pressure will cause premature failure of and increase maintenance in susceptible areas such as the shaft seal and heater.

OPERATING TEMPERATURE							
180°F	190°F	200°F	210°F	220°F	230°F	240°F	250°F
20 PSI	25 PSI	30 PSI	35 PSI	40 PSI	45 PSI	50 PSI	55 PSI
WATER SUPPLY PRESSURE							

Figure 2.2A

- C. The factory recommended minimum operating water supply pressure requirement is identified on the unit's data tag (figure 2.2B).
- D. Static water supply pressure can be determined at the unit's location by reading the unit's 0-160 PSI pressure gauges when the unit's pump motor is **OFF**.
- E. If water supply pressure as read on the unit's pressure gauges exceeds 75 PSI, a **pressure reducing valve** must be installed in the water supply line (refer to section 7.4 of this manual for installation information). The factory recommended 'regulated pressure out' is 55 PSI (figure 2.2C).



Typical Data Plate

Figure 2.2B



Typical pressure reducing valve installation (shown on S-925).

Figure 2.2C

2.4 DRAIN CONNECTION:

- A. Connect the unit's **DRAIN** port to one of the following, determined by the water supply source:
 1. Open drain for well or city water supply.
 2. Tower water system return for tower system water supply.
 3. Chilled water system return for chilled water system supply.

B. The factory recommends a minimum of 10 psi pressure differential between the water supply and drain line for proper cooling.

C. For most applications, the drain line should not be valved. However, for installations with a pressurized drain system, it may be necessary to install a valve in the drain line. In such cases, the installed valve must be fully opened after installation and the valve handle removed to prevent operating the unit with a closed drain valve. The valve handle can be reattached to the valve body when it is necessary to close the valve (figure 2.3A).



Typical drain valve installation (Shown on S-925) Figure 2.3A

D. **CAUTION:** The unit must never be operated with a closed drain line valve. A closed drain line valve prevents adequate system cooling and will lead to unit overheating. Overheating of the unit may lead to unit damage and/or serious personal injury.

2.5 ELECTRICAL CONNECTION

A. NEMA 1 MODELS

1. Electrical power supply requirements for Nema 1 units are identified on the equipment data tag. Verify that available voltage supply is the same as the unit's voltage requirements.

WARNING: DO NOT CONNECT THE UNIT TO A VOLTAGE SUPPLY SOURCE NOT EQUAL TO THE UNIT'S VOLTAGE REQUIREMENTS AS SPECIFIED ON THE UNIT'S DATA PLATE.

Use of incorrect voltage will void the unit's warranty and cause a significant hazard that may result in serious personal injury and/or unit damage.

2. For units with 10 and 16 KW heaters, a four conductor cable, 10 foot in length, has been provided for connection to an operator supplied fused disconnect.
3. For units with 24 and 34 KW heaters, the operator must provide a four conductor power cable and the fused disconnect.
4. The owner supplied fused disconnect must be sized and installed according to the unit's power supply requirements and local electrical codes.

B. NEMA 12 MODELS

1. Nema 12 units are designated by the letter “J” in the model number suffix. These units are constructed with a dust tight electrical enclosure and branch circuit fusing. Electrical power supply requirements are identified on the equipment data tag. Verify that available voltage supply is the same as the unit’s voltage requirements.

WARNING: DO NOT CONNECT THE UNIT TO A VOLTAGE SUPPLY SOURCE NOT EQUAL TO THE UNIT’S VOLTAGE REQUIREMENTS AS SPECIFIED ON THE UNIT’S DATA PLATE.

Use of incorrect voltage will void the unit’s warranty and cause a significant hazard that may result in damage to the unit or serious personal injury.

2. Appropriate conduit and fittings should be selected which will maintain the integrity of the cabinet.
3. Supply a power conductor sized according to the unit’s power supply requirements. Connect the power conductor to the unit’s power supply entry terminal block.

C. CONTROL CIRCUIT WIRING

1. The unit’s supplied control circuit is 110 volt, 1 phase, 60 cycle. The control circuit is supplied by the factory installed transformer. A control circuit fuse is provided (figure 2.5C).



Typical control circuit transformer fuse

Figure 2.5C

D. GENERAL

1. Make certain all ground connections to the unit are properly affixed. A proper connection to earth ground is required. A conduit ground is not a reliable conductor!
2. Make certain the power conductor, disconnecting means, and fusing are properly sized according to the unit’s power supply requirements.
3. Make certain all electrical connections are tightly affixed. Any loose wiring connections must be tighten before engaging the power supply.
4. Make certain no moisture or standing water is present inside the electrical cabinet.

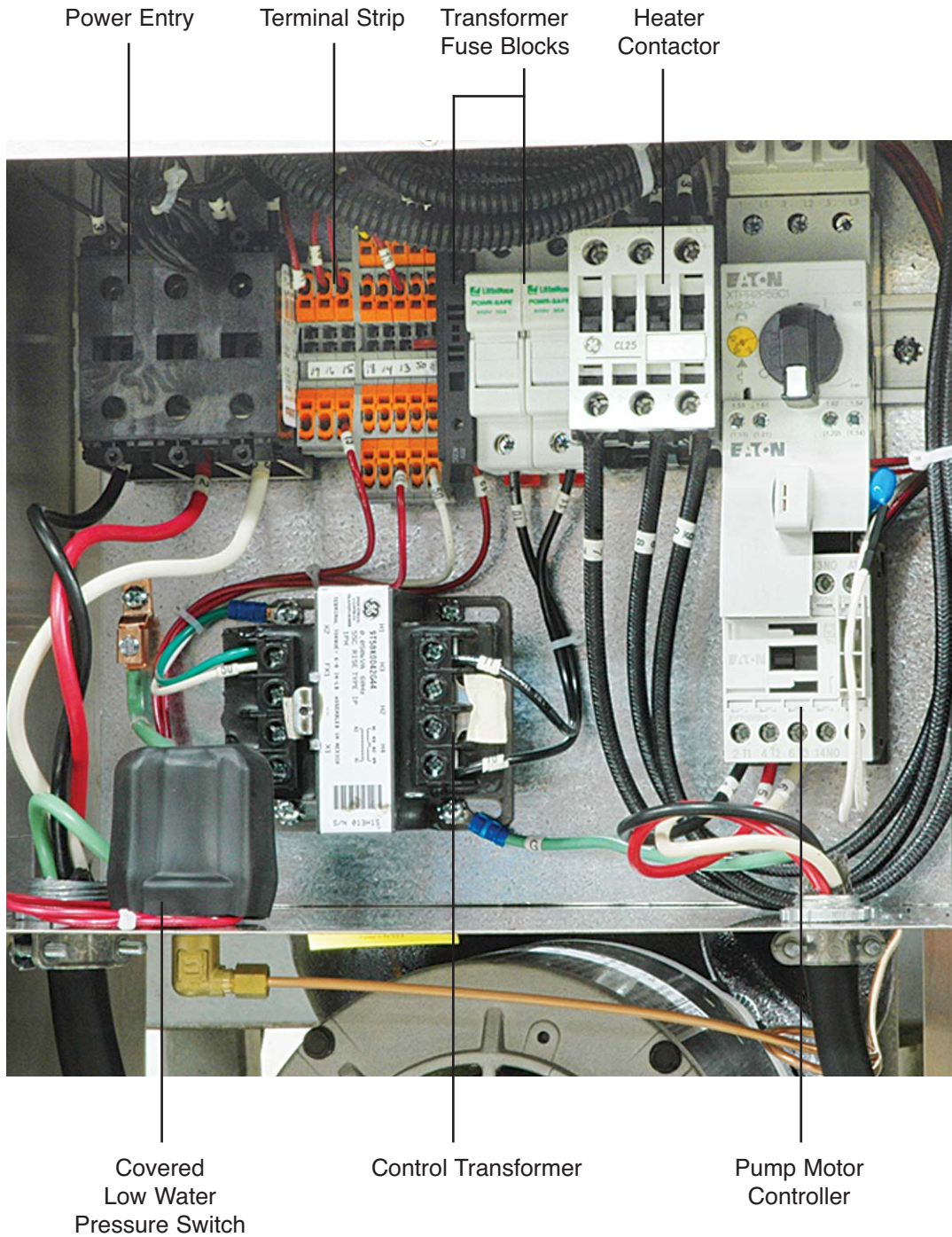

3.0 OPERATIONS

- 3.1 GENERAL**
- 3.2 MACHINE START UP/OPERATIONS PROCEDURE**
- 3.3 INSTRUMENT OPERATION**
- 3.4 SHUT DOWN/DISCONNECT PROCEDURE**



3.1 GENERAL

- A. Failure to follow the factory required operation procedures may adversely affect the unit's ability to adequately control process temperature and may create a hazardous operating condition which may result in unit damage or serious operator injury.
- B. The Operations segment of this manual is outlined below:
 - 3.2 **Machine start-up/operations procedure** - follow this segment to start the unit after the initial installation or to restart the unit after reinstallation to the same or different process. This section includes information on system fill, electric motor phasing (pump rotation) and process flow adjustments.
 - 3.3 **Instrument Operation** - follow this segment to start up and operate the instrument. This section includes information on automatic and manual venting, setpoint selection and adjustment, and feature explanations.
 - 3.4 **Shut down procedure** - follow this segment to shut down the unit. This segment includes information on system cool down, shut down, electrical power supply precautions, and disconnection from the system.

3.2 MACHINE START UP/OPERATIONS PROCEDURE

A. SYSTEM FILL

- 1. Engage the water supply source by opening the water supply valve (customer installed) at the unit's location. If a valve is not installed, engage the water supply source at the plant's water supply central control point.
- 2. Once the water supply source is open, the unit will fill automatically. Allow a few moments for the unit to completely fill. The operator can determine the unit is properly filled when the *To Process* pressure gauge and the *From Process* pressure gauge stabilize at equal or closely similar pressure.
- 3. The operator must check for any water leakage in the unit's mechanical system, the process, and throughout the plant's water supply system. If a water leak is observed, the operator must disengage the water supply system, relieve all pressure, and repair the leak. The operator must verify the leak is repaired by refilling the system as outlined in this procedure.



4. During system fill, air is trapped at various places in the water system. Air is purged automatically via the AVT™ valve during initial pump start-up (outlined below). All air must be purged before the unit is engaged for process temperature control.

Entrained air in the system will adversely affect the unit's ability to control process temperature. The operator can determine all entrained air is purged when no pressure spikes are evident via the unit's pressure gauges.

5. Adequate water fill and pressure must be supplied to the unit for efficient and safe operation. To ensure sufficient water fill, an electrical panel mounted pressure switch (figure 3.2A) is supplied with the unit. A capillary line feeds the pressure switch. If the water supply pressure is not adequate the unit can



Panel mounted pressure switch Figure 3.2A

not be operated. This prevents operation with inadequate water fill and pressure. If the unit is operated without adequate water fill and pressure, the unit may be susceptible to overheating and could result in unit damage and/or serious injury to operating personnel.

B. ELECTRIC MOTOR PHASING (PUMP ROTATION)

1. The operator must determine the electric motor is phased correctly. This is done by visually inspecting the rotation of the motor shaft as outlined below. Incorrect phasing of the unit results in poor operation and eventual damage.
 - a. Supply electrical power to the unit by engaging the unit's disconnect switch. Once the correct voltage is supplied to the unit, the *Power* light on the display will illuminate.
 - b. Remove the thermoformed cover panel and open the hinged electrical cabinet panel cover. **Note that the electrical power is engaged at this point and caution must be observed while the electrical supply is engaged and the cabinet panel is open.**
 - c. Locate the electric motor (figure 3.2B) and identify the motor shaft inside the electric motor housing. The motor shaft can be seen through the vent slots in the motor housing or by removing the shaft cover.

d. Toggle the *On / Off* switch. This will cycle the motor “on” and then “off”.

e. Observe the motor shaft as it slows to a stop to identify the rotation. Correct rotation is “clockwise”, when viewed from the

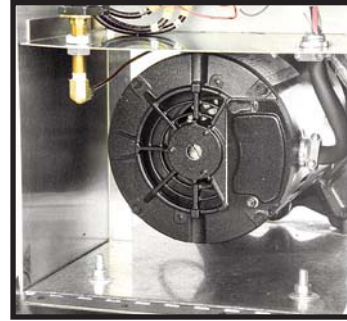

Remove shaft cover to view the motor shaft

Figure 3.2B

rear of the motor. Incorrect rotation is “counter-clockwise” when viewed from the rear of the motor. If the shaft does not rotate when the unit is started, the operator must identify the cause as outlined in this manual’s troubleshooting and repair section.

f. If the unit is phased correctly, continue with the start up procedure at **step C**. If the unit is phased incorrect, continue with **step 2**.

2. To correct unit phase:

a. Disengage the electrical power supply to the unit at the unit’s disconnect switch. Follow proper lockout procedures before proceeding.

b. Once the electrical power supply is disengaged, reverse any two power leads of the power cord at the fused disconnect terminals.

c. **Note: The operator must reverse the power leads at the disconnect only and not at the power entry terminals on the unit’s electrical panel** (figure 3.2C).

The unit’s internal electrical system wiring is phased correctly at the factory and must not be altered in the field.

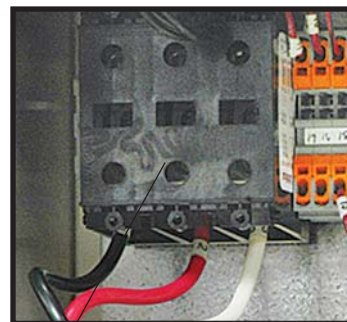

DO NOT reverse power leads At the unit's power entry

Figure 3.2C

3. To visually verify pump rotation, start the unit and observe the pressure gauges. The *To Process* pressure will indicate 35-50 PSI more than the *From Process* pressure. In this state, the pump rotation is correct (clockwise). If this is not evident the unit is not correctly phased and should be corrected as outlined in **step 2**.

C. PROCESS FLOW ADJUSTMENTS

1. The operator must determine and set proper water flow rate for the most efficient and trouble free operation.
 - a. Water flow rate through the process is determined by the pressure losses in the process loop. Generally, higher flow rates result in turbulent flow achieving maximum temperature control and lower maintenance.
 - b. If the flow rate exceeds the motor HP capacity, the electric motor will draw excessive amps. This is a result of the process loop's ability to flow water at a greater rate than can be provided by the pump. This will eventually result in tripping the thermal motor overload relay (overload relays open) and the unit will shut down and illuminate the *Safety* and *Alarm* lights on the display.

2. If an excessive flow situation is encountered and the motor overload circuit has tripped, the operator must manually reset the overload relay before operations can continue. This is done by opening the electrical panel cover, identifying the reset lever on the overload relay (figure 3.2D), and pushing the reset lever "in" until the overloads are reset (evidenced by a "clicking" sound as the overloads reset).

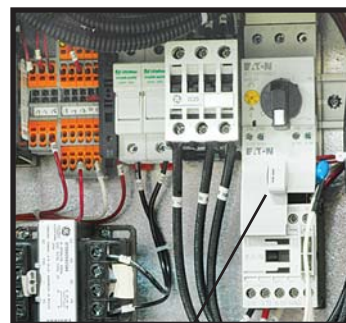

Pump Motor Controller Figure 3.2D

3. If a motor overload situation persists, the operator must adjust the flow rate to match the system pressure loss (reduce flow rate) to prevent continual tripping of the overload relay. This procedure is outlined here:
 - a. Open electrical cabinet panel door. The panel cover is hinged and held open by a support cable. **Note that the electrical power is engaged at this point and caution must be observed while the cabinet panel is open.**
 - b. Identify the motor starter block. This block consists of the motor starter contactor and the overload relay.
 - c. Place an amp meter on a single power lead coming from the overload relay.

- d. Locate the motor name plate on the pump motor housing (figure 3.2D). The full load amp rating for the motor is listed on the name plate.



Motor name plate

Figure 3.2D

- e. Engage the electrical power supply and start the unit.

- f. The amp meter will display the motor amps. Compare the actual motor amps as displayed on the amp meter to the full load amp rating as listed on the motor name plate.

- g. If the amp draw is excessive (higher than the listed name plate amp rating), a throttling valve must be installed in the “from process” water line. The throttling valve can be a gate valve or a ball valve.

- h. With the throttling valve installed, fully close the valve and then engage the pump motor. Slowly open the throttling valve and monitor the motor amps as displayed on the amp meter until the actual motor amps equal the listed full load amp rating of the motor. The process flow is now correctly adjusted. The valve should remain in this position during operation.

6. **LOW PROCESS FLOW:** The minimum recommended process flow rate is 10 GPM. Process restrictions may limit the flow to less than 10 GPM. We recommend the addition of bypass lines to raise the flow rate to 10 GPM. The best place to add bypass lines are on the extra ports on the molding machine manifold. If extra ports are not available, add a tee in the *To Process* and *From Process* lines, install a bypass line between the two tees with a throttling valve. Adjust the valve for a minimum of 10 GPM.

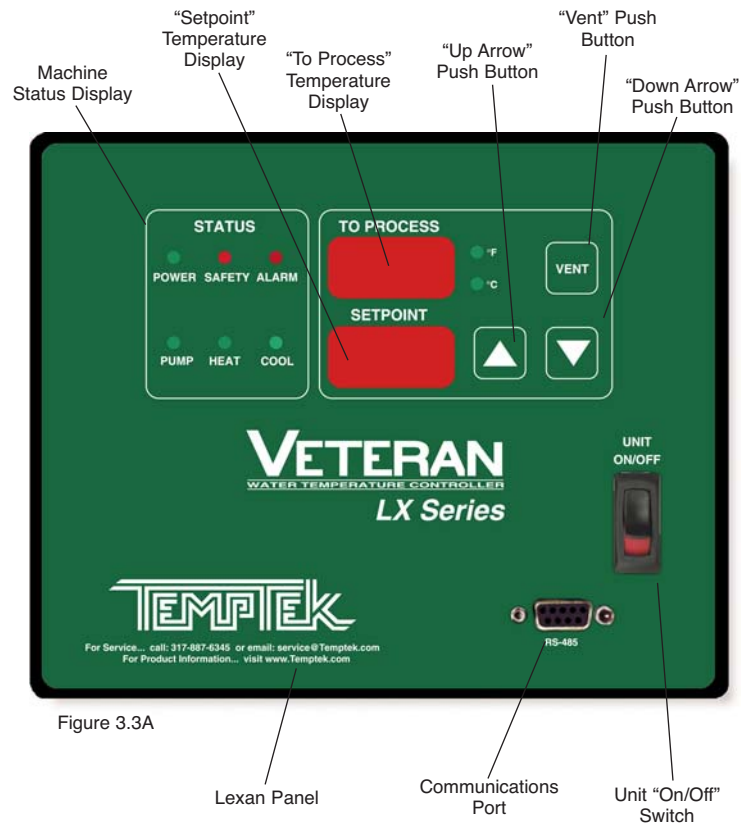

Figure 3.3A

3.3 INSTRUMENT OPERATION

A. INSTRUMENT START-UP

1. When the correct electrical power and adequate water supply pressure are supplied to the unit, it is possible to start the unit for temperature control duty.
2. When the electrical power supply is engaged to the unit, the instrument (figure 3.3A) will momentarily illuminate all indicating lights and digits. The instrument continues the diagnostic routine and cycles through the following:
 1. All LED's 'ON', '8.8.8'
 2. Version number, '1.00'
 3. Sequence through:
 - 'b96' SPI baudrate: b96 | b48 | b24 | b12
 - 'c 1' SPI COMM addr, 1-8
 - 'd10' Alarm band deviation, d10 | d5
 - 'Ho' Heat only, NO AVT valve
 4. Setpoint, '1.8.0'
 5. Process temperature, '180'

At this time, the operator can verify that all lights and digits are functioning properly. If the operator determines an

indicating light or digit does not illuminate, the controller must be removed and sent to the factory for repair.

3. The instrument will immediately check the status of the sensor probe, the high temperature safety switch, the water supply pressure switch and the AVT™ valve for acceptable operating conditions. If all systems are found to be 'ok', the unit will begin process temperature control operation. If a system is not found to be 'ok', the instrument will prevent process temperature control operation and will illuminate the *Safety* light and *Alarm* lights on the display.
4. Conditions that will prevent the unit from starting process temperature control operations are (the *Safety* light on the display will illuminate if one of these conditions exist):
 - a. **Water supply pressure inadequate.** The unit is prevented from operating without adequate water supply pressure by an electrical panel mounted pressure switch. Sufficient water supply pressure must be present to close the switch and consent the safety circuit.
 - b. **Motor overload switch opened.** The electric motor is protected from excessive flow conditions by a set of thermal overload relays. These relays will open (trip) and prevent electric power from reaching the electric motor. If the overload relay is open, the overload relay must be reset before operations can continue. Excessive flow conditions must be corrected immediately.
 - c. **High temperature limit switch open.** The unit is prevented from operations with temperatures exceeding 256°F by a "high temperature limit switch". This switch is installed in the "to process" temperature sensor. If this switch is open (due to a high temperature condition), the control circuit is not consented and the unit cannot be started. If a high temperature condition exists, the unit must first "cool down" (reduce water temperature) before the "high temperature limit switch" will automatically reset to allow operation.
 - d. **AVT™ fault.** When power is applied, the AVT™ valve begins a "homing process". The valve is turned forward and backward across a limit switch to establish the valve position. If valve position cannot be established, a fault will be displayed in the *Temperature* display window as *ULU*. Refer to section 5.3 for AVT™ service and repair instructions.



- e. **Temperature sensor.** Failure of the *To Process* temperature sensor will be indicated in the *Temperature* display by a *PRB ERR*. Check the sensor cable and connector for loose wires or moisture. If no problems are found, replace the sensor.

B. INSTRUMENT OPERATION

1. Process temperature control operation is started by switching on the *On / Off* rocker switch.
2. When the unit is turned on, the instrument will display the previously selected setpoint temperature in the *Setpoint* window. The setpoint temperature is displayed continuously.

The instrument normally display temperature in Fahrenheit or Celsius as selected by DIP SW8. When an *Up Arrow* or *Down Arrow* push button is pressed the current setpoint is displayed with all (3) decimal point 'on'. The setpoint will remain on the display for three (3) seconds after a button is released.

3. Also, the instrument will display the *To Process* temperature as read by the temperature sensor, which is mounted at the top of the heater/discharge tank. All instrument functions are based on this temperature.
4. If the indicated *To Process* temperature is less than 100°F, the instrument will automatically open the AVT™ modulating cooling valve for 30 seconds. This "automatic system vent cycle" will purge entrained air from the process system to the drain. Automatic venting is indicated by a flashing *Cool* light on the display. If the automatic vent cycle does not result in the venting of all entrained air to the drain (evidenced by a "rattling" sound in the unit and fluctuating pressure gauges), the operator must manually vent the system by holding the *Vent* push button. If the *To Process* temperature exceeds 100°F, the instrument will bypass the automatic system vent cycle.

5. SELECTING SETPOINT TEMPERATURE

The operating setpoint temperature is selected by pressing the *Up Arrow* or *Down Arrow* push buttons. If a button is pressed momentarily the setpoint value is displayed for 3 seconds.

All three decimal points are "ON" during setpoint display.

If the *Up Arrow* or *Down Arrow* push button is pressed momentarily while the setpoint display is active, the setpoint



will increment or decrement by one (1). When a button is held down for more than one second, the setpoint will be changed slowly at first and then faster after 5 second.

Hold until the preferred setpoint temperature is indicated in the *Setpoint* display window. Setpoint temperatures can be adjusted anytime during the process temperature control cycle.

Setpoint Control Range: +32°F to +250°F (0°C to +121°C)

C. INSTRUMENT CONTROLS

1. UNIT ON/OFF SWITCH:

This rocker switch engages/disengages electrical supply to the pump, heater and AVT™ modulating cooling valve (figure 3.3A).



On/off rocker switch

Figure 3.3A

2. VENT PUSH BUTTON:

Depress and hold this push button to initiate a forced vent of the unit by opening the AVT™ modulating cooling valve. By pressing this button, the operator can quickly cool the unit on demand (figure 3.3B).

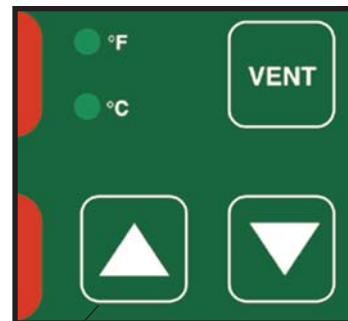

Vent and arrow push buttons

Figure 3.3B

3. UP ARROW:

Depress and hold this push button to increase the setpoint temperature. Press momentarily to increment the value by one degree. Press and hold for more than one second, the value will increase slowly at first and then faster after about two seconds. The setpoint control range is 32° to 250°F (0° - 121°C) (figure 3.3B).

4. DOWN ARROW:

Depress and hold this push button to decrease the setpoint temperature. Press momentarily to increment the value by one degree. Press and hold for more than one second, the value will increase slowly at first and then faster after about two seconds. The setpoint control range is 32° to 250°F (0° - 121°C) (figure 3.3B).

D. SENTRA LE STATUS INDICATING LIGHTS (figure 3.3C)

1. **POWER ON:** Illuminates when electrical power is applied to the unit.
2. **PUMP:** Illuminates when the *On / Off* rocker switch is turned "on" and the motor pump is operating and there are no safety faults. Even with the *On / Off* rocker switch "on", the PUMP light will not illuminate if a safety fault condition exists.

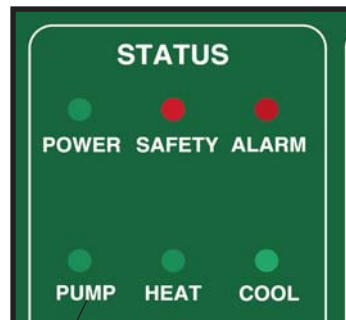

Sentra LE status indicating lights Figure 3.3C

3. **HEAT:** Illuminates when the instrument engages the heater contactor. Engaging the heater contactor supplies electrical current to the flange mounted heater in the discharge tank. This increases process water temperature.
4. **COOL - SOLID:** This light will illuminate (solid - not flashing) when the instrument opens the AVT™ valve. Opening the AVT™ valve will discharge a stream of process water to the drain and allows cooling water from the water supply source to enter the circulating system and mix with the heated process water. This reduces process temperature.
5. **COOL - FLASHING:** This light will flash when the unit is started and the process water temperature is less than 100°F and the unit is automatically venting to expel entrained air from the system. The instrument will autovent for approximately 30 seconds.
6. **SAFETY - FLASHING:** This light will illuminate (flashing) when a safety fault exists. A fault must exist for 5 seconds before the light flashes. The operator must isolate the cause before operations can continue. The following items will cause the *Safety* light to illuminate:
 - a. **Water supply pressure inadequate (pressure switch is open).** The unit is prevented from operation without adequate water supply pressure by an electrical panel mounted pressure switch. Sufficient water supply pressure must be present to close the switch and consent the circuit to the electric motor starter.
 - b. **Motor overload switch opened.** The electric motor is protected from overload conditions (excessive flow) by a set of thermal overload relays. These

relays will open (trip) and prevent electric power from reaching the electric motor. If the overload relay is open, it must be reset before operation can continue. An excessive flow condition must be isolated and corrected immediately.

- c. High temperature limit switch open.** The unit is prevented from operations at temperatures exceeding 256°F by a “high temperature limit switch”. This switch is installed in the “to process” temperature sensor. If this switch is open (due to a high temperature condition), the control circuit is not consented and the unit cannot be started. If a high temperature condition exists, the unit must first “cool down” before the “high temperature limit switch” will automatically reset.
 - D. AVT™ fault.** When the unit is started, the AVT™ valve begins a “homing process”, where the valve is turned forward and backwards across a limit switch. This establishes the valve position. If the valve position cannot be established, a fault will be displayed in the *Temperature* window as *ULU*. Refer to section 5.3 for AVT™ service and repair instructions.
 - E. Temperature Sensor.** Failure of the *To Process* temperature sensor will be indicated in the *Temperature* display window by a *PRB ERR*. Check the sensor cable and connector for loose wires or moisture. If no problems are found, replace the sensor.
- 7. SAFETY - SOLID:** The *Safety* light will be solid (not flashing) when all safety fault conditions have been isolated and corrected. A solid *Safety* light can be cleared by depressing the *Up Arrow* or *Down Arrow* push buttons.
 - 8. ALARM:** This light illuminates when an alarm fault exists. The three safety fault items described above (water supply pressure switch open, motor overload switch open, high temperature limit switch open) will trigger an *Alarm* light. The single item that will trigger an *Alarm* light and will not trigger a *Safety* light is an “out of temperature band” alarm, which occurs when the process temperature drifts above or below the 5° or 10° temperature deviation band as programmed by the DIP switch settings. The factory setting is 10°.

Clear an Alarm indication by pressing the *Up Arrow* or *Down Arrow* push buttons.
 - 9. °F:** illuminates when the DIP switch #8 is set to “on”. The



factory set “temperature display” is ° F (see figure 3.3B).

10. °C: illuminates when the DIP switch #8 is set to “off” (see figure 3.3B).

E. COMM PORT

1. 9-pin D-Shell for SPI communications.

PIN#	Function
1	Signal Common
2	n.c.
3	n.c.
4	RD+/TD+
5	RD-/TD-
6	n.c.
7	n.c.
8	RD+/TD+
9	RD-/TD-

F. DIP SWITCH

1. The 8 position DIP switch located on the top edge of the controller board is used to set:

Communication baudrate : *9600, 4800, 2400, 1200
 Port Address : *1-8
 Motor Type :
 Units Display : * Fahrenheit or Celsius

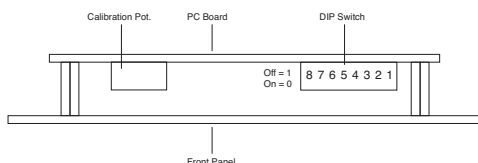
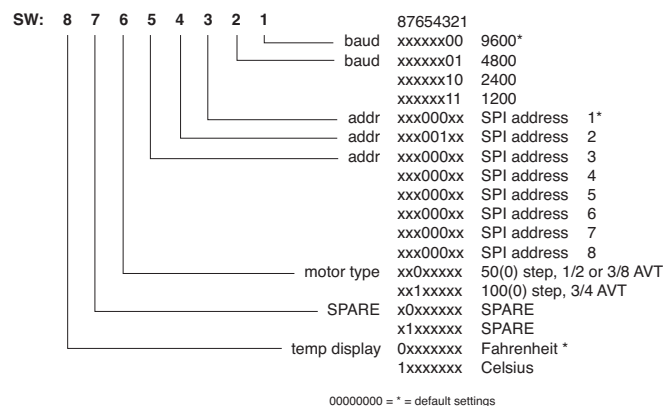

G. ADVANCED SETUP

1. To access the advanced setup mode depress both the *Up Arrow* or *Down Arrow* push buttons and then release. Use the *Vent* push button to select through the parameters listed below.

2. Advance setup features:

SP: Setpoint. Use *Up Arrow* or *Down Arrow* push buttons to adjust (range 0°F - 250°F).

Hi: Hi Temperature Deviation Alarm. Use *Up Arrow* or *Down Arrow* push buttons to adjust (range 0° - 50°F).

Lo: Low Temperature Deviation Alarm. Use *Up Arrow* or *Down Arrow* push buttons to adjust (range 0° - 50°F).

ULU: Valve Offset. Use *Up Arrow* or *Down Arrow* push buttons to adjust (range 1 - 250) default 40.

Note: Setting for initial valve opening, use to tune cooling response.

PAL: Pump Active Alarm. When activated will activate alarm output whenever pump is not running. Will alarm until power is disconnected, or pump is restarted (on/off).

Aut: Autovent activation temperature (range 0° - 250°F) default 100°F.

Auc: Autovent Time (range 0 - 250 seconds) default 45 seconds.

Note: Unit will autovent whenever pump is started and temperature is below temperature setting.

3.4 SHUT DOWN/DISCONNECT SEQUENCE

A. PRECAUTIONS/WARNINGS

1. The operator must precisely follow all shut down procedures outlined in this manual. If the operator fails to do so, an unsafe condition can develop resulting in damage to the unit or injury and/or death to operating personnel.
2. When disconnecting the unit from the process system, the operator must determine the unit's process temperature is



at ambient or below 85°F and all system pressure is relieved and the unit's pressure gauges read "0". Injury or death to operating personnel and damage to the unit could result if a hot and pressurized unit is disconnected from the system.



Pressure relief valve

Figure 3.4A

B. UNIT SHUT DOWN (without system disconnect)

1. Adjust the setpoint temperature to 32°F. The instrument will disengage the heater contactor (if engaged) and fully open the AVT™ valve. Operate the unit until process temperature as indicated on the *Temperature* display is at the ambient water supply temperature or below 85°F.
2. Stop operations by pressing the *Stop* push button.
3. Disengage the water supply to the unit by closing the water supply valve (if installed) or by turning off the water supply source at the central control point. If any residual pressure is evident open the pressure relief valve (figure 3.4A) to dissipate.
4. Disengage the power at the fused disconnect. Determine the *Power* light on the display is **OFF**.
5. Before disconnecting and removing the process circuitry, be certain all system pressure is vented and the pressure gauges read "0". When the process circuitry is disconnected and removed from the unit, a small amount of water will be discharged from the unit. Please note that this water should not be warm or pressurized if all shut down and disconnecting procedures were followed. Remaining process water can be discharged by removing the pump casing drain plug.

THIS PAGE INTENTIONALLY BLANK

4.0 TROUBLESHOOTING

- 4.1 UNIT WILL NOT START (POWER LIGHT IS NOT ILLUMINATED)
- 4.2 UNIT WILL NOT START (POWER LIGHT IS ILLUMINATED)
- 4.3 UNIT STOPS
- 4.4 UNIT OVERHEATS
- 4.5 UNIT UNDERHEATS
- 4.6 PRESSURE RELIEF VALVE LEAKS
- 4.7 COOLING VALVE FAULT "ULU"



4.1 UNIT WILL NOT START (POWER LIGHT IS NOT ILLUMINATED)

- A. One or more fuses at the main disconnect device are open (blown). Determine continuity at each fuse. If continuity is not determined, replace the fuse. Then determine cause of blown fuse.
- B. Control circuit transformer fuse is open (blown). Determine continuity at the control circuit transformer fuse. If continuity is not determined, replace the fuse.

4.2 UNIT WILL NOT START (POWER LIGHT IS ILLUMINATED)

- A. **Power supply is ON.** The operator can determine that electrical power supply to the unit is “on” by an illuminated *Power* light on the display. Even with the main power supply on, the unit is prevented from operating by one of the following conditions:
 - 1. ***Water supply pressure inadequate.*** (pressure switch is open). The unit is prevented from operation without adequate water supply pressure by the electrical panel mounted pressure switch. Sufficient water supply pressure must be present to close the switch.
 - 2. ***Motor overload switch opened.*** The electric motor is protected from overload conditions by a set of thermal overload relays. These relays will open (trip). If the overload relay is open, it must be reset before operation can continue. An excessive flow condition must be isolated and corrected immediately.
 - 3. ***High temperature limit switch open.*** The unit is prevented from operations at temperatures exceeding 256°F by a “high temperature limit switch”. This switch is installed in the *To Process* temperature sensor. If this switch is open (due to a high temperature condition), the unit cannot be started and must “cool down” before the “high temperature limit switch” will automatically reset.

4.3 UNIT STOPS

- A. The operator should determine the main power supply to the unit is **ON** by an illuminated *Power* light on the display. With the main power supply “on”, the unit will be prevented from starting by the following conditions:
 - 1. ***Water supply pressure inadequate.*** (pressure switch is open). The unit is prevented from operation without adequate water supply pressure by the electrical panel mounted pressure switch. Sufficient water supply pressure must be present to close the switch.
 - 2. ***Motor overload switch opened.*** The electric motor is protected from overload conditions by a set of thermal



overload relays. These relays will open (trip). If the overload relay is open, it must be reset before operation can continue. An excessive flow condition must be isolated and corrected immediately.

3. **High temperature limit switch open.** The unit is prevented from operations at temperatures exceeding 256°F by a “high temperature limit switch”. This switch is installed in the *To Process* temperature sensor. If this switch is open (due to a high temperature condition), the unit cannot be started and must “cool down” before the “high temperature limit switch” will automatically reset.

B. The operator should check the *Power* light on the display. The operator should check the following conditions:

1. One or more fuses at the main disconnect device are open (blown). Determine continuity at each fuse. If continuity is not determined, replace the fuse. Then determine cause of blown fuse.
2. Control circuit transformer fuse is open (blown). Determine continuity at the control circuit transformer fuse. If continuity is not determined, replace the fuse.

4.4 UNIT OVERHEATS

A. This is evidenced by *To Process* temperatures consistently above the selected setpoint temperature. Overheating is also evidenced by a *To Process* temperature that continues to escalate above the setpoint temperature with no apparent cooling action, even though the *Cool* light is on. Extreme overheating is evidenced by *To Process* temperatures over 256°F. The operator should check for the following conditions:

1. **Inadequate water supply pressure.** The unit must be supplied with adequate water flow to provide cooling when required. The minimum pressure differential between the water supply and drain to achieve full cooling capacity is 10 PSI. The minimum water supply pressure is 20 PSI. A drop in water supply pressure operation will cause the pump to stop and a safety fault to be displayed.
2. **AVT™ valve defective.** The instrument opens and closes the AVT™ cooling valve in incremental steps between 0 to 100% as prescribed by the current process load. A continual discharge stream of process water to drain is present under most operating conditions (except at full heat-up). This allows the unit to maintain virtual straight-line control of process water temperature. If the AVT™ valve becomes clogged with process water debris or scaled with



mineral deposits, its operation is hindered or fully prevented and adequate process water discharge to drain is prevented. The operator must remove the AVT™ valve and remove any loose debris. Massive debris or scale deposits may necessitate replacement of the AVT™ valve. The procedure for servicing the AVT™ valve is outlined in Section 5.3 of this manual.

3. **Drain line obstruction.** The operator must determine if the drain line is obstructed by the following conditions. Section 2.4 outlines the parameters of correct drain line installation.
 - a. **Closed drain line valve.** An installed but partially or fully closed valve in the drain line prevents full discharge to drain and contributes to an overheating condition. The operator should determine the drain line is open.
 - b. **High drain back pressure.** Pressurized plant drain lines will prevent flow to drain if the differential between the water supply pressure and the drain line pressure is inadequate. The factory recommended minimum differential is 20 psi. If the differential is less than the factory recommendation, plant service personnel should take measures to reduce drain line pressure.
4. **Instrument defective.** The instrument is designed and manufactured exclusively by TempTek. The instrument is life-tested and found to be field reliable. However, in the case where the instrument is determined to be defective, the operator must remove the assembly according to instructions outlined in section 5.8 and return the assembly to the factory. The instrument is not a field serviceable component.

4.5 UNIT UNDERHEATS

- A. This is evidence by operations with *To Process* temperatures consistently below the selected setpoint temperature.
 1. **Process water leakage.** When the instrument engages the heater to elevate process temperature, the input of heat into the process can be offset by a defective AVT™ valve. If the AVT™ valve is defective, it may pass a larger than required stream to drain, thus providing unwanted cooling. A defective AVT™ valve should be repaired immediately.
 2. **Heater element failure.** A failed heater element will not input adequate heat into the process to elevate the process water temperature. The operator must check the amps at the heater contactor with the contactor energized. Zero



amps at the contactor indicate a failed heater or burnt wire connections. The operator should remove the failed heater and replace with a new heater according to the procedure outlined in section 5.2.

3. **Unit capacity too low.** This occurs when the process requires more heat than the unit is capable of producing. The only option in such cases is to install a unit with an adequate heater KW rating for the load.
4. **Instrument defective.** The instrument is designed and manufactured exclusively by TempTek. The instrument is life-tested and found to be field reliable. However, in the case where the instrument is determined to be defective, the operator must remove the assembly according to instructions outlined in section 5.8 and return the assembly to the factory. The instrument is not a field serviceable component.

4.6 PRESSURE RELIEF VALVE LEAKS

- A. The unit has a 150 psi pressure relief valve mounted in the cooling cylinder. If the valve is found to be leaking, the operator should check the following:
 1. **Water supply pressure exceeds 75 psi.** The unit is designed to operate with water supply **NOT** exceeding 75 psi. See section 2.3 paragraph B for specific water supply pressure requirements at corresponding setpoint temperatures. If the plant water supply pressure exceeds 75 psi, the pressure relief valve may leak. Static water supply pressure can be determined at the unit's location by reading the unit's 0-160 PSI pressure gauges when the unit's motor pump is off. If the water supply pressure at the unit's location exceeds 75 PSI, a pressure reducing valve must be installed in the water supply line. The factory recommended 'regulated pressure out' is 55 PSI. Refer to section 7.4 for regulator installation drawing.
 2. **Back flow prevention device in water supply line.** If a back flow prevention device (check valve, pressure regulator, closed valve) is installed in the water supply line, increased pressures from thermal expansion are unable to move into the water supply line. This will increase the unit's internal pressure causing the pressure relief valve to leak. Refer to section 7.4 for regulator installation drawing.
 3. **Valve contamination.** The pressure relief valve may become contaminated with water debris causing the valve not to close properly. If this is the case, flushing the valve for a moment will cleanse the seat and allow it to work properly. If flushing the valve does not remedy the leaking, the valve must be replaced.



4. **Extreme internal system pressure.** If the internal pressure in the **Sentra** unit is elevated, the pressure relief valve will leak as a safety measure to dissipate excessive pressure. If this is the case, the operator must determine why the system internal pressure is excessive and correct the condition.

4.7 COOLING VALVE FAULT

- A. **AVT™ FAULT.** When power is applied, the AVT™ valve begins a 'homing process'. The valve is turned forward and backward across a limit switch to establish the valve position. If valve position cannot be established, a fault will be displayed in the *Temperature* display window as *ULU*. Refer to section 5.3 for AVT™ service and repair instructions.



5.0 SERVICE/MAINTENANCE

- 5.1 PUMP SEAL REPLACEMENT**
- 5.2 HEATING CYLINDER SERVICE**
- 5.3 AVT™ COOLING VALVE SERVICE**
- 5.4 PROBE CALIBRATION**
- 5.5 VOLTAGE CHANGEOVER**
- 5.6 SENSOR PROBE SERVICE**
- 5.7 PRESSURE SWITCH SERVICE**
- 5.8 INSTRUMENT SERVICE**
- 5.9 CONFIGURING TEMPERATURE DISPLAY UNITS**
- 5.10 CONFIGURING ALARM TEMPERATURE PARAMETER**
- 5.11 CONFIGURING COMMUNICATIONS RATE**
- 5.12 ELECTRONIC INSTRUMENT REPAIR POLICY & PROCEDURE**



5.1 PUMP SEAL REPLACEMENT

A. The pump seal is a carbon/ceramic shaft seal assembly including a stationary member, rotating member and tension spring (figure 5.1A).

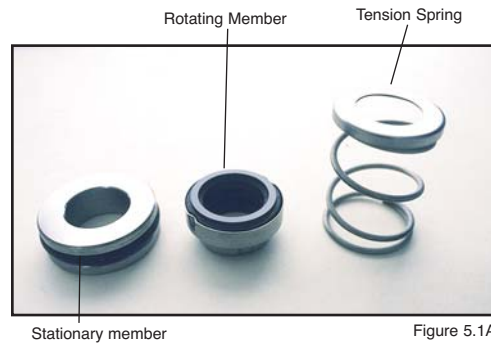

B. The life cycle of the pump seal is determined by hours of use, operating temperature and water quality. Poor water quality is the primary reason for premature pump seal failure.

D. The operator should follow this procedure to replace the pump seal:

1. Disengage process operations and relieve all system pressure.
2. Disengage main power supply. Verify the *Power* light on the display is "off".
3. Remove the lift-off access panel and set aside (Figure 5.1B).
4. Remove the thermoformed panel. It is attached to the stainless steel cabinet by 4 small screws (figure 5.1C).
5. Drain machine by removing the pump casing drain plug.
6. Remove the three motor wire leads from the motor wiring terminals. The operator should "map" the wire terminal locations to ensure correct rewiring. The power cord should be removed from the motor housing (figure 5.1D).



Remove lift-off access panel Figure 5.1B



Thermoformed panel removed and electrical cabinet open.

Figure 5.1C

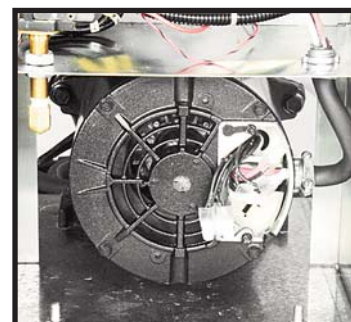

Motor leads

Figure 5.1D

7. Locate and remove the 4 pump casing bolts. These bolts secure the motor and motor adapter to the pump casing (figure 5.1E).
8. Separate the motor and adapter from the pump casing to expose the pump impeller (figure 5.1F). Remove the motor and adapter from the unit and place on a workbench to continue the procedure.
9. Locate and remove the dust cap from the motor to expose slotted motor shaft. The motor shaft is free to rotate, but must be secured to remove the impeller. To secure the motor shaft, insert a flat bladed screw driver in slot to hold the shaft stationary (figure 5.1G).
10. Locate and remove impeller locking screw (figure 5.1H). Using a socket and ratchet, the impeller retaining screw can be removed. Once removed, the impeller can be “unthreaded” from the motor shaft to expose the pump seal assembly.
11. Remove all seal parts (figure 5.1I). Note seal component arrangement to facilitate reassembly.
12. Clean the motor shaft and lubricate with a mild soap solution. **Note: Oil must never be used as a lubricant as it will damage the rubber parts of the seal assembly.**

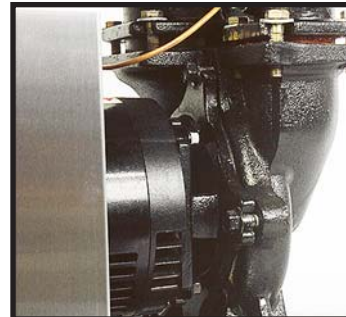

Pump casing bolts

Figure 5.1E

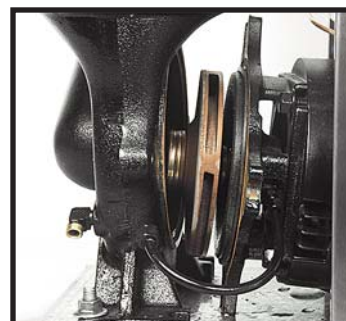

Impeller

Figure 5.1F



Motor shaft

Figure 5.1G

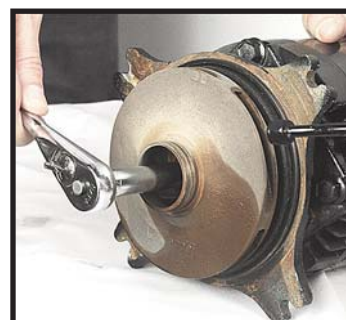

Removing impeller locking screw with ratchet

Figure 5.1H

13. Install new stationary seal member in pump casing cavity (figure 5.1J). Be certain the stationary seal member is fully squared and seated in cavity.



Seal components

Figure 5.1I

14. Slide the rotating member onto the lubricated pump shaft (figure 5.1K). Be certain not to damage or tear the rubber bellows assembly.



Stationary member

Figure 5.1J

15. Place the spring onto the rotating member.

16. Align the tension spring and rotating member before reinstalling the impeller (figure 5.1L). Be certain the spring and rotating member are aligned before the impeller is fully tightened and the impeller retaining screw is reinstalled.



Rotating member

Figure 5.1K

17. Clean the pump casing, cavities, impeller and O-ring before reassembly.

18. Mate the motor and adapter to the pump casing. Reinstall the 4 pump casing bolts.

19. Reconnect the motor power cord and leads.

20. Replace the thermoformed front panel and the lift-off cover.



Aligning impeller and spring

Figure 5.1L

E. When this procedure is complete, the operator may restart the unit. In many cases, a new pump seal will experience a small amount of leakage for a short time. This is normal. After a few moments, the new seal will take seat and the leak will stop.

5.2 HEATER REPLACEMENT

A. The heater is a flange mounted assembly and inserted into the cast cylinder tank and secured by 4 bolts (figure 5.2A).



Heater

Figure 5.2A

B. The operator can determine if the heater requires replacement when the heater draws "0" amps or when a continuity check of each heater element is negative.

C. Generally, heaters fail due to low water flow, low water pressure, air in the system or defective heating elements.

D. The operator should follow this procedure to replace the heater:

1. Disengage operations and be certain all system pressure is relieved and the unit's pressure gauges read "0".

2. Disengage main power supply. Verify the *Power* light on the display is "off".

3. Remove the lift-off access panel and set aside

4. Drain machine. The machine can be drained by removing the pump casing drain plug.

5. Remove heater's junction box cover to locate wiring connections. The operator should note the wiring connections to ensure correct reinstallation (figure 5.2B).

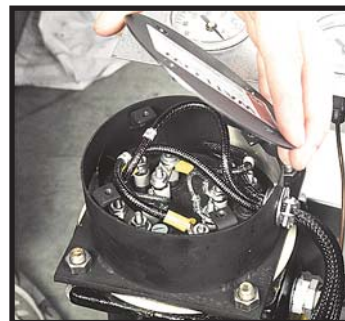

Heater junction wires

Figure 5.2B

6. Disconnect the three power leads from the heater terminals. Remove the power cord from the junction box.

7. Remove the 4 heater mounting bolts (figure 5.2C).



Heater mounting bolt

Figure 5.2C

8. Remove heater (figure 5.2D).

9. Before the new heater is installed, the mating surface of the cast tank should be cleaned. Once cleaned, place the new heater gasket onto the tank mating surface. Coat the mating surface with a high temperature gasket sealant.

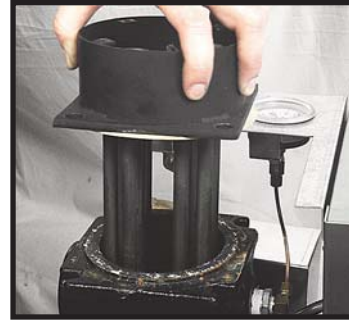

Remove heater

Figure 5.2D

10. Set new heater into tank. Aligning the bolt pattern of the heater and tank flanges.
 11. Replace the 4 heater mounting bolts. Alternate to the opposite bolt while tightening.
 12. Reconnect the power cable to the heater terminals. Be certain to tighten the power cord junction box connector. Replace the junction box cover and the lift-off cover panel.
- D. When complete, restart the unit.

5.3 AVT™ COOLING VALVE SERVICE

- A. The AVT™ cooling valve is a two component assembly, consisting of the motor/gearbox and valve assembly, mated with a machined aluminum coupling. The AVT™ valve assembly is sheltered by a thermoformed drip cover (figure 5.3A). The drip cover is secured by two nuts and can be removed. When removed, the AVT™ valve components can be viewed (figure 5.3B).

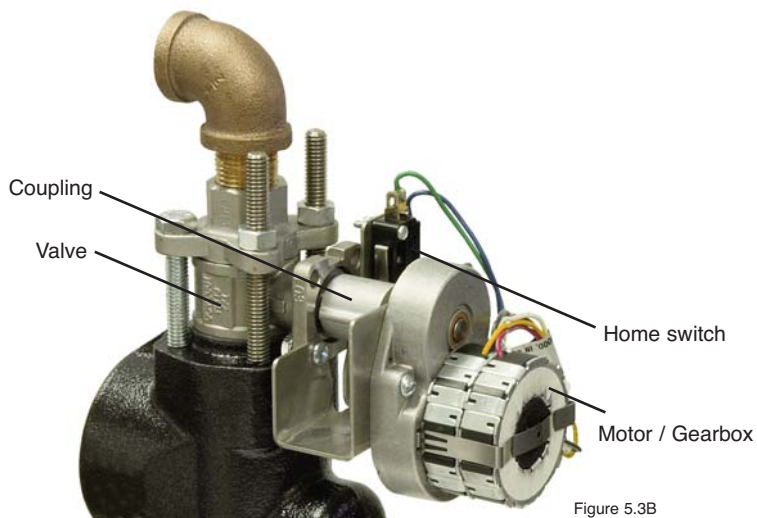
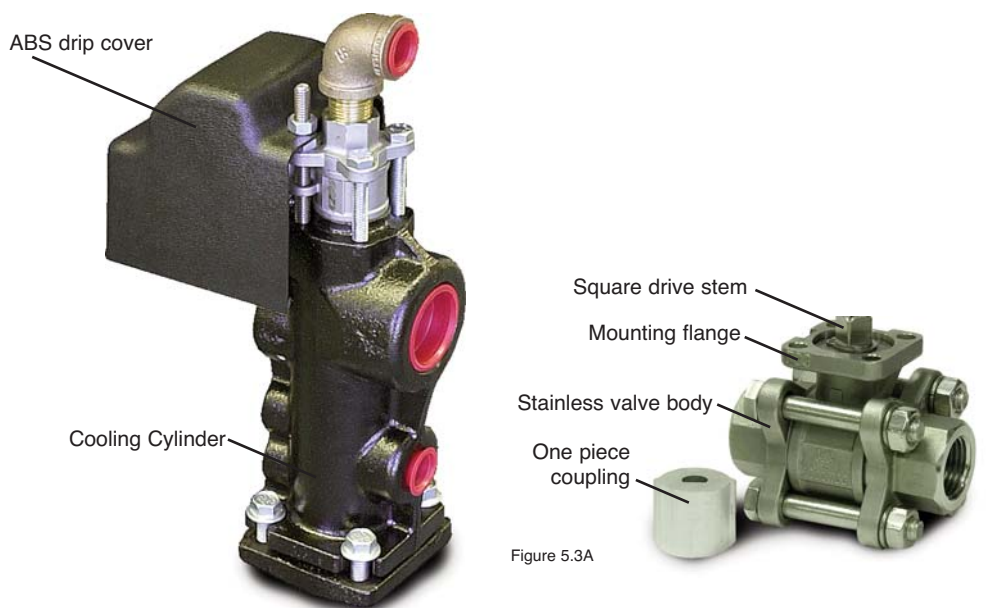

- B. The conditions that require servicing of the AVT™ modulating valve are as follows:
1. **Motor/gearbox assembly defective.** This condition is evidenced by non-movement of the motor when prompted by the instrument. This is evident when power is engaged

to the instrument. The instrument will turn the motor in an attempt to find "home base". If no movement is observed, most likely the motor/gearbox assembly is defective. To be certain, remove the motor as outlined below, maintain the electrical connection and supply power to the instrument. If the motor does not turn, the motor/gearbox should be replaced. If the motor does turn, the operator can determine the valve assembly is defective.

2. **Valve assembly defective.** The valve assembly may become fouled with process debris or the internal components may be defective.
- C. The components of the AVT™ valve can be serviced separately. To begin the AVT™ valve service procedure, proceed with steps 1 - 5:
1. Disengage process operations and verify all system pressure is relieved and the unit's pressure gauges read "0".
 2. Disengage main power supply and verify the *Power* light on the display is "off".
 3. Remove the lift-off access panel and set aside.
 4. Disconnect the valve wiring harness.
 5. Remove the AVT™ valve's drip cover.
- D. To service the motor driver/gearbox components, continue with steps 6 - 12:
6. The motor/gearbox assembly is mounted to the valve bracket and is secured by 2 mounting screws.
NOTE: It will also be necessary to remove the 2 screws that secure the micro switch to completely remove the motor since they are hard wired together.
 7. Remove the 2 mounting screws. The motor and gearbox will now be loose. Carefully separate the motor/gearbox from the attached coupling from the valve assembly.
 8. Align the motor/gearbox and coupling to the valve assembly.
 9. Align the motor/gearbox assembly mounting holes to the holes in the cooling cylinder. Replace the 2 mounting screws and loosely install the microswitch screws.
 10. Reconnect the wiring harness. Home base is the reference point from which the controller is able to open the valve incrementally. If the unit is not able to find home, a valve



fault "ULU" will appear in the *Temperature* display window. Adjust the home switch to clear the fault.

11. **Adjusting the home switch.** Apply power. The coupling should begin to turn. When the lobe on the coupling is directly under the roller for the microswitch, turn off the power. Adjust the microswitch so that the roller fully depresses the microswitch. Turn on the power and the valve should turn forward and backwards a few times and then stop at the home position. The valve light should be green and you may begin operation. See diagram on next page.

NOTE: Important... the valve stem should be in this position (as indicated in the diagram) and the valve

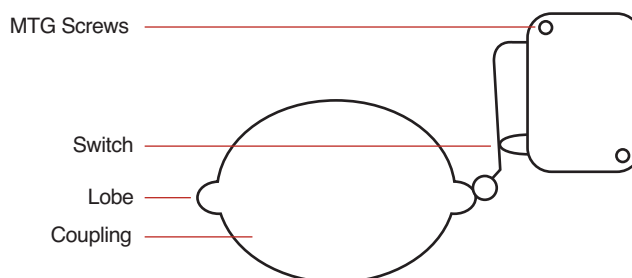

should be CLOSED. If the valve is open, manually turn the square stem 90° so that the valve is closed.

- E. To service the valve components, continue with steps 13 - 20:
 12. Be certain the unit is totally depressurized with the unit's pressure gauges reading "0". The unit should be drained if possible.
 13. The valve assembly is a ball valve specially designed only to work with the AVT™ motor. The valve assembly is secured to the cooling cylinder by a top plate and 4 mounting screws. The drain connection originates at the valve top plate with a brass elbow and close nipple fitting. The connection can be maintained when servicing the valve.
 14. Remove the 4 mounting screws. The top plate, mounting bolts, valve assembly and the mounting plate with the attached micro-switch will now be loose. Carefully separate the valve from the motor/gearbox.
 15. At this step, the valve can be rebuilt or replaced. To rebuild the valve, order PN 8764939, and install new stem packing O-ring, seal rings, and seats (see diagram below). Once the valve is back together, continue with **step 17**:

16. Aligned the valve assembly coupling to the motor/gearbox and place on the cooling cylinder. A gasket or seal is not required.
17. Replace the top plate, the micro switch mounting plate and the 4 mounting bolts. Tighten the 4 mounting bolts alternating to the opposite bolts.
18. Once power is reapplied, the instrument will align the AVT™ modulating valve to “home base”. Home base is the reference point from which the controller is able to open the valve incrementally. Process operations can resume. If the unit is not able to find home, a valve fault *ULU* will appear in the temperature display. Readjust the home switch to clear the fault. Adjust the home switch as needed (as outlined in Step 11).

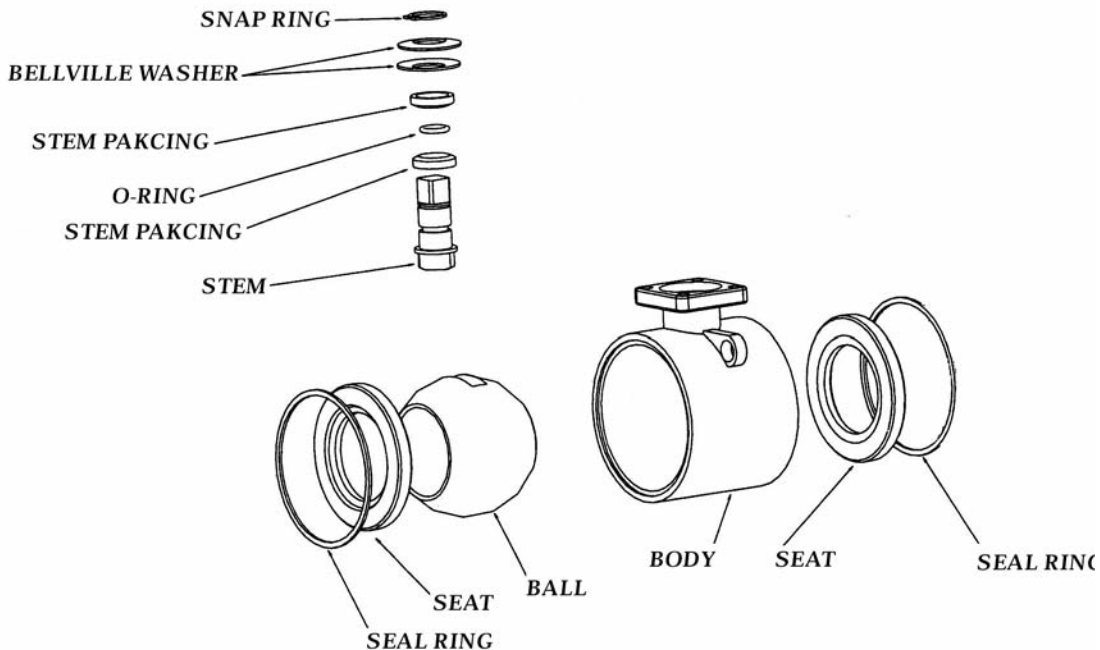

5.4 PROBE CALIBRATION

- A.** The temperature probe (figure 5.4A) is a temperature transducer. The transducer is embedded into a threaded bulb well. The transducer converts the temperature of the water into a proportional current output, which the microprocessor controller reads, displays, and bases its controlling functions. The gain is automatically calibrated within the microprocessor electronics. The zero adjustment potentiometer is located on the CPU.

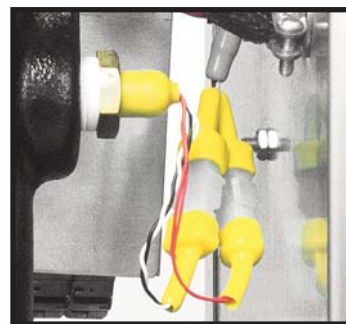

Typical sensor probe

Figure 5.4A

- B.** The temperature transducer and instrument circuitry is very stable. A small drift may occur over time. To ensure correct temperature reading, calibrate the probe annually or per your facility calibration standards. Operation in high humidity and high vibration environments may require more frequent calibration.
- C.** The operator should follow this procedure to calibrate the probe.

1. Disengage process operations and verify all system pressure is relieved and the unit's pressure gauges read "0".
2. Disengage main power supply and verify the *Power* light on the display is "off".
3. Remove the *To Process* temperature probe and insert a 1/2" plug in its place (figure 5.4B). To complete the calibration procedure, the unit will be operated at full flow and pressure. The plug is to maintain the mechanical integrity of the unit during the calibration procedure.

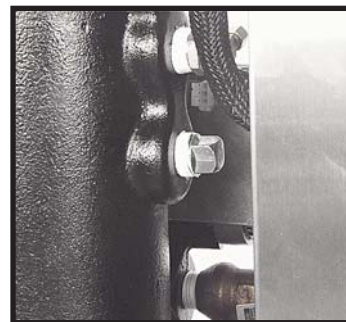

Plug

Figure 5.4B

4. Prepare an ice water bath. The operator should place an accurate digital thermometer in the ice water bath to read the temperature of the bath. The probe will be calibrated to the temperature of the ice water bath.
5. Place the probe in the ice water bath.
6. Start the unit.

7. Reduce the unit's set point, via the *Down Arrow* push button to 32°F.
8. With the unit in the operations mode, the "to process" temperature on the display should equal the temperature of the ice water bath as indicated by the digital thermometer. If not, the operator must change the calibration of the probe.
 - a. To access the calibration potentiometer, open the electrical cabinet panel door. The panel door is secured by a support strap. Caution must be employed when the electrical panel door is open since power is applied to the unit.
 - b. Locate the instrument CPU. The calibration pot is located on the "mother board" of the instrument assembly (figure 5.4C).
 - c. Use a non-conductive device, to adjust the potentiometer. Adjust the potentiometer until the "to process" temperature on the display equals the temperature of the ice bath.
9. When the two temperatures ("to process" and ice water bath) are equal, the calibration procedure is complete.
10. Shut down the unit. The operator must be certain to remove the 1/2" plug and replace the sensor probe. Restart operations.

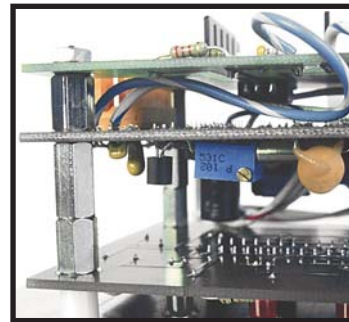

Calibration port

Figure 5.4C

5.5 VOLTAGE CHANGEOVER

- A. Some units can undergo a field voltage conversion by qualified technicians. Consult with the Temptek Service Department to determine if your unit can be converted. Have your Serial Number ready and call 317-887-0729.
- B. Typical Conversions for 1/2 to 7.5 horsepower motors and 10 to 16 kW heaters:
 1. 240/3/60 to 480/3/60
 2. 480/3/60 to 240/3/60
 3. 480/3/60 to 208/3/60

Consult factory for other power conversions.

- B. For a field voltage changeover, the following items will require replacement or rewiring:
 1. Heater (rewiring)
 2. Motor (rewiring)
 3. Transformer (rewiring)
 4. Motor starter and overload block (replace)
 5. Replace unit data tag with tag stating new voltage and amp rating.

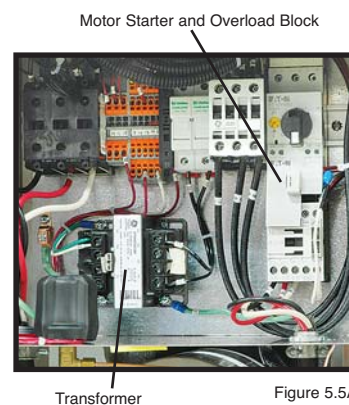

- C. The qualified technician should follow this procedure to complete a field voltage changeover:
 1. Disengage operations and verify all system pressure is relieved and the unit's pressure gauges read "0".
 2. Disengage main power supply. **Follow proper lock-out procedures.** The operator must verify the *Power* light on the display is "off".
 3. Remove the lift-off access panel and set aside. (figure 5.5A)
 4. Rewire the heater to the new voltage. Figure 5.5B shows the wiring for 230 and 460 volt heaters.
 5. Remove the thermoformed front panel and open the electrical cabinet panel door. Unplug the instrument connectors to fully extend the hinged panel.



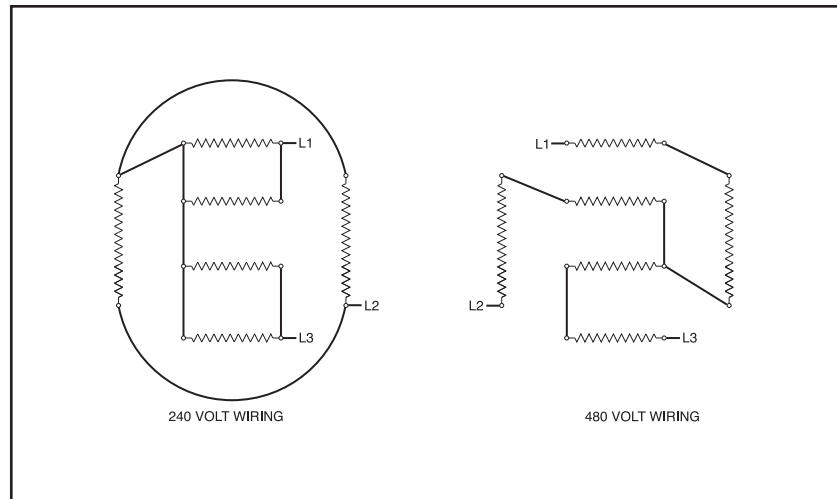

Wiring schematics for 240 and 480 volt heaters

Revised 4/11

Figure 5.5B

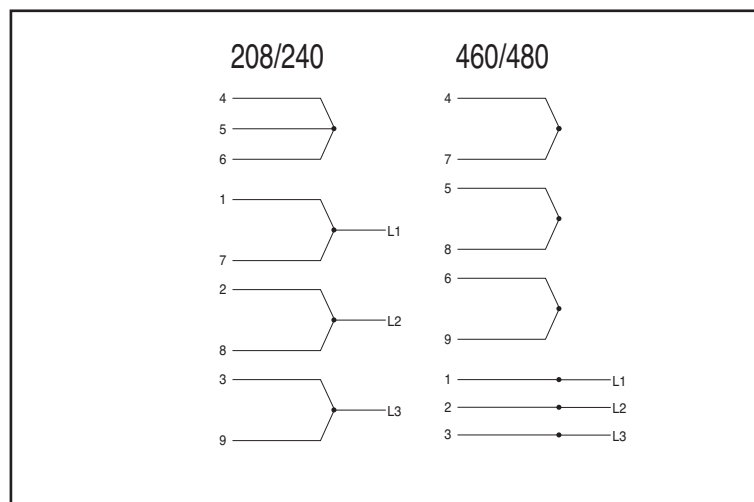

Wiring schematics for 240 and 480 volt pump motors

Figure 5.5C

6. Rewire the pump motor for the new voltage. Most Sentra pump motors are dual voltage. Figure 5.5C shows the wiring schematic for 240 and 480 voltages.
7. Rewire the transformer to the proper voltages as shown by the schematic on the transformer (figure 5.5D).
8. Replace the motor starter and overload block. Adjust the overload block settings

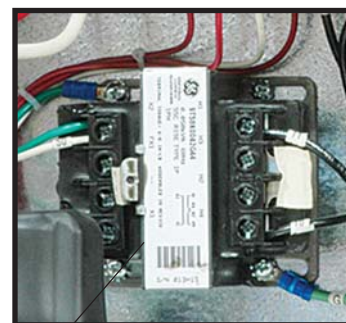

Transformer

Figure 5.5D

for the current draw at the new voltage (figure 5.5E).

9. Once a voltage change is complete, be certain the unit is properly connected to the new voltage supply, as outlined in **section 2.5** of this manual. Restart unit operations according to **section 3** of this manual.

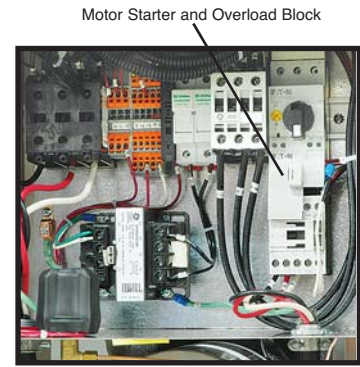

Figure 5.5E

5.6 SENSOR PROBE SERVICE

- A. Each temperature probe (figure 5.6A) is a temperature transducer. The transducer is embedded into a bulb well, which is threaded into the tank. The transducer converts the temperature of the water into a proportional current output, which the microprocessor controller reads, displays, and bases its controlling functions on. The gain is automatically calibrated within the controller electronics, the zero adjustment potentiometer is located on the CPU.

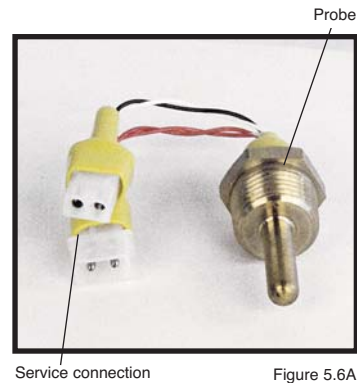

Figure 5.6A

- B. Sensor probe errors are indicated by the *Probe* light on the instrument with a *Flashing Red* display. When a sensor probe error is displayed, take the following steps to correct:
1. **RECONNECTION.** If the service connection of the sensor probe becomes saturated with water. Simply unplug the connection, shake out the water to clear the service connection and replug. If this was the problem, the error display should change to *Solid Red* which can be cleared by pressing the *Start* push button. If not, continue with replacement.
 2. **REPLACEMENT.** Replacement of the sensor probe involves ceasing process operations (as outlined in section 3.4 of this manual) and removing the defective sensor probe. All factory supplied replacement probes are complete with the service connection. Unit with 'HE' Series instruments use two sensor probes: A "to process" and a "from process". The "high temperature limit" safety switch is a part of the "to process" sensor probe. To replace any sensor probe, follow the procedure as outlined below:
 - a. Stop process operations as described in **section 3.4** of this manual.
 - b. Determine that all process pressure is relieved and the unit's pressure gauges read "0" pressure.
 - c. Drain the unit by removing the pump casing drain plug. The unit can be drained only to below the sensor probe mount if preferred.
 - d. Disconnect the sensor probe service plug.
 - e. Using a crescent wrench, remove the sensor probe

from the cylinder. To install a new sensor probe continue as follows:

- f.** The new sensor probe threads should be lined with teflon tape and coated with leak preventative sealant. Using a crescent wrench, thread the new sensor into the machined boss of the cylinder.
- g.** Reconnect the service connection. Restart the unit as outlined in **section 3** of this manual.



5.7 PRESSURE SWITCH SERVICE

- A. The unit is protected from low pressure operations by a pressure switch (figure 5.7A). This switch is mounted at the bottom of the electrical cabinet.
- B. The switch will close and consent the control circuit when sufficient water supply pressure is presented. The switch is factory set to 20 psi.
- C. If insufficient water supply pressure is present, the switch will open and prevent operations.

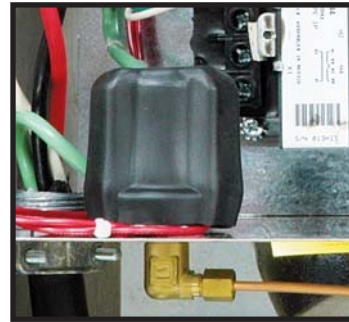

Pressure switch

Figure 5.7A

- D. In cases where sufficient water supply pressure is present as indicated by the unit's pressure gauges and the pump is "off", and if the pressure switch fails to close, the pressure switch may be defective. To replace the pressure switch, follow the steps outlined:
 1. Shut down unit operations according to **section 3.4** in this manual. Be certain proper lock-out procedures are followed. Also, be certain system pressure is eliminated and the unit's pressure gauges read "0" pressure.
 2. Drain unit by removing the pump casing drain plug.
 3. A capillary runs from the cooling cylinder to the pressure switch. Remove the capillary connection.
 4. The brass elbow mounted on the pressure switch must be removed.
 5. Remove the electrical connections to the pressure switch.
 6. The pressure switch is mounted onto the electrical cabinet with two 1/2" nuts in series. Remove the nuts to remove the pressure switch. A new pressure switch from the factory should be installed by continuing with **step 7**.
 7. Thread one 1/2" nut onto the pressure switch and then place the pressure switch through the panel in the original mounting hole. Thread the second 1/2" nut from the bottom of the pressure switch. Tighten to lock the pressure switch in place.
 8. Install the brass elbow fitting. Teflon tape and leak preventative paste should be used to prevent water leakage. Install the capillary tube and resume operations.

5.8 INSTRUMENT SERVICE

A. The instrument controller is a microprocessor based instrument designed to cycle the heater and AVT™ modulating cooling valve to maintain process temperature at setpoint (figure 5.8A) .

B. The instrument is not a field serviceable component. If the instrument is determined to be in need of repair, the operator must remove the assembly and return it to the factory for repair.



Sentra HE instrument

Figure 5.8A

C. To service the instrument, take the following steps:

1. Disengage process operations according to the procedure outlined in **section 3.4**. The operator must be certain all system pressure is relieved and the unit's pressure gauges read "0".
2. Disengage main power supply and verify the *Power* light on the display is "off".
3. Remove the thermoformed front panel and set aside. The panel is attached to the stainless steel cabinet by 4 small screws.

4. Open the hinged electrical cabinet panel cover. The panel is opened by removing four small screws.

5. The instrument is mounted on the electrical cabinet panel cover. The instrument is secured by four mounting bolts. A series of electrical connections link the instrument to the mechanical components of the unit (Figure 5.8B).

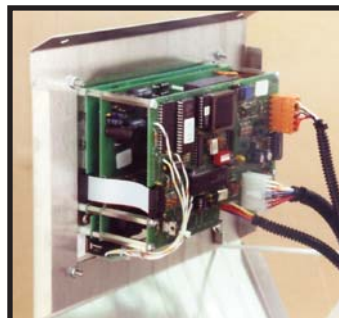

Connections

Figure 5.8B

5. Remove the large moxex connector.
6. Remove the ground terminals.
7. Remove the sensor plug.

8. Remove the four mounting nuts. The instrument is now loose and can be removed. To reinstall a factory issued instrument, continue with step #9.
9. Place the instrument into the panel mount, aligning the four mounting stems. Once the instrument is aligned, tighten the nuts to secure the instrument.
10. Connect the sensor plug.
11. Connect the ground terminals.
12. Connect the large molex connector.
13. The operator can now start the unit as outlined in **section 3** of this manual. The operator must reconfigure (if necessary) the instrument to restore the preferred operating parameters.



5.9 CONFIGURING TEMPERATURE DISPLAY UNITS

- A. The operator may program the instrument to display temperature in either Fahrenheit or Celsius.
- B. Fahrenheit temperature display is indicated by the "° F" light. Celsius temperature display is indicated by the "° C" light (figure 5.9A).
- C. The operator should follow this procedure for configuring the temperature display units.

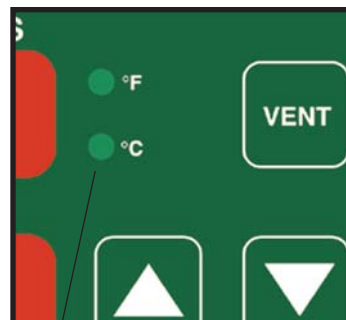

Temperature display lights

Figure 5.9A

1. Disengage process operations according to the procedure outlined in **section 3.4**. The operator must be certain all system pressure is relieved and the unit's pressure gauges read "0".
2. Disengage main power supply. The operator must verify the *Power* light on the display if "off".

3. Remove the thermoformed front panel and set aside. The panel is attached to the stainless steel cabinet by 4 small screws. Open the electrical cabinet panel door.

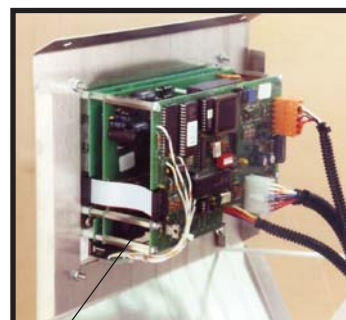

Instrument chassis

Figure 5.9B

4. Locate the instrument CPU (figure 5.9B). The DIP switch is located on the 'mother board' of the instrument assembly.

5. Locate switch #8 (figure 5.9C). Use a small, non-conductive device and gently position the DIP switch to the appropriate setting for Fahrenheit or Celsius display.

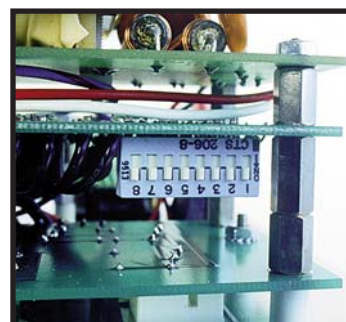

DIP Switches

Figure 5.9C

6. When the switch is set, close the electrical cabinet panel door.

7. Restart the unit according to the procedure outlined in section 3 of this manual. The new selection takes effect immediately.

5.10 CONFIGURING ALARM TEMPERATURE PARAMETER

- A. The operator may program the instrument to signal an alarm (figure 5.10A) if the “to process” temperature deviates over 5° or 10° from the “setpoint” temperature. The factory alarm temperature parameter is set at 10°F.

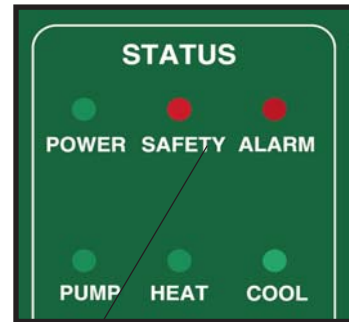

Alarm light

Figure 5.10A

- B. The instrument must bring the process temperature to setpoint and then maintain the setpoint temperature before the alarm temperature feature is armed. If the process temperature deviates from the setpoint temperature after the initial setpoint “lock”, then the instrument will signal the *Alarm* light.
- C. The operator should follow this procedure to configuring the alarm temperature parameter:
1. Disengage process operations according to the procedure outlined in **section 3.4**. The operator must be certain all system pressure is relieved and the unit’s pressure gauges read “0”.
 2. Disengage main power supply. The operator must verify the *Power* light on the display is “off”.
 3. Remove the thermoformed front panel and set aside. The panel is attached to the stainless steel cabinet by 4 small screws. Open the electrical cabinet panel door.
 4. Locate the instrument CPU. The DIP switch is located on the “mother board” of the instrument assembly.
 5. Locate switch #7 (figure 5.10B). Use a small, non-conductive device and gently position the switch to the appropriate setting 5° or 10° alarm.
 6. When the switch is set, close the electrical cabinet panel door.
 7. Restart the unit according to the procedure outlined in **section 3** of this manual. The new selection takes effect immediately.

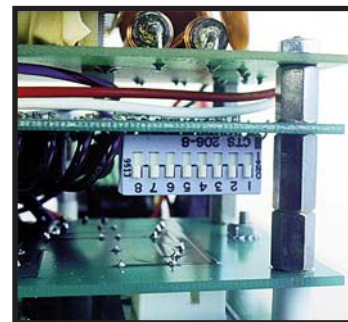

DIP Switches

Figure 5.10B

5.11 CONFIGURING COMMUNICATIONS RATE

- A. The operator may program the controller for communications at 1200, 2400, 4800 and 9600 BAUD. The factory setting is 9600 BAUD.
- B. The operator should follow this procedure to configure the communications parameter:
 1. Disengage process operations according to the procedure outlined in **section 3.4**. The operator must be certain all system pressure is relieved and the unit's pressure gauges read "0".
 2. Disengage main power supply. The operator must verify the *Power* light on the display is "off".
 3. Remove the thermoformed front panel and set aside. The panel is attached to the stainless steel cabinet by 4 small screws. Open the electrical cabinet panel door.
 4. Locate the instrument CPU. The DIP switch is located on the "mother board" of the instrument assembly.

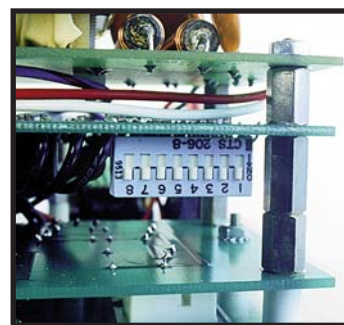

DIP S witches Figure 5.11A

5. Locate switches #1 and #2 (figure 5.11A). Use a small, non-conductive device and gently position the switches to the appropriate settings according to the chart below.
6. When the switches are set, close the electrical cabinet panel door.
7. Restart the unit according to the procedure outlined in **section 3** of this manual. The new selection takes effect immediately.

DIP SWITCH #									
OFF - 1	ON - 0	8	7	6	5	4	3	2	1
X	X	X	X	X	X	0	0	—	9600 - factory default
X	X	X	X	X	0	1	—	4800	
X	X	X	X	X	1	0	—	2400	
X	X	X	X	X	1	1	—	1200	
X	X	X	0	0	X	X	—	SPI ADDRESS #1 - factory default	
X	X	X	0	1	X	X	—	SPI ADDRESS #2	
X	X	X	0	1	0	X	—	SPI ADDRESS #3	
X	X	X	0	1	1	X	—	SPI ADDRESS #4	
X	X	X	1	0	0	X	—	SPI ADDRESS #5	
X	X	X	1	0	1	X	—	SPI ADDRESS #6	
X	X	X	1	1	0	X	—	SPI ADDRESS #7	
X	X	X	1	1	1	X	—	SPI ADDRESS #8	
X	X	X	X	X	X	X	—	RESERVED	
X	0	X	X	X	X	X	—	10 _i F ALARM BAND - factory default	
X	1	X	X	X	X	X	—	5 _j F ALARM BAND	
0	X	X	X	X	X	X	—	FAHRENHEIT - factory default	
1	X	X	X	X	X	X	—	CELSIUS	

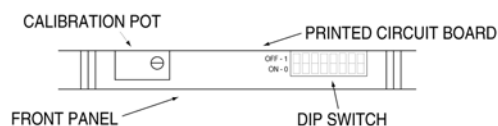

5.12 ELECTRONIC INSTRUMENT REPAIR POLICY AND PROCEDURE

- A.** All control instruments used in Temptek temperature control units are covered by the machine's warranty. Proprietary 'tailor made' instrument are manufactured specifically for Temptek by our affiliated company Advantage Electronics.
- B. IN WARRANTY SERVICE INCIDENT**
1. Call the factory for diagnostic assistance.
 2. If a control instrument is determined to be at fault, a new or reconditioned instrument will be sent as a replacement.
 3. Return the defective instrument freight pre-paid for full credit. If the defective instrument is not returned you will need to pay for it.
- C. OUT OF WARRANTY SERVICE INCIDENT**
1. Call the factory for diagnostic assistance.
 2. If a control instrument is determined to be at fault, you will be referred to the instrument manufacturer, Advantage Electronics (an affiliated company. There are 3 options.
 - a. Purchase a new instrument as a replacement.
 - b. Send your instrument back for repair, freight prepaid. For a nominal fee, your instrument will be repaired and returned.
 - c. Purchase a new instrument and repair the old one as a back up.
 3. If you are sending your instrument back for repair, call the Service Department for more information. Do not disassemble the instrument.
- D. Other Information:**
1. Call the factory for current repair charges.
 2. Repair warranty: 1 year.
 3. Ship to Advantage Electronics, 525 East Stop 18 Road, Greenwood, IN 46143. Attention: Repairs (317-887-1946). Include in the shipping box: Part, purchase order, contact name, phone number, and symptom (if available).
 5. For Priority service, send the instrument to the factory via overnight shipment. We usually repair these instruments the same day we receive them.



6.0 COMPONENTS

- 6.1 MECHANICAL SYSTEM**
- 6.2 ELECTRICAL SYSTEM**



6.1 MECHANICAL SYSTEM

A. MOTOR/PUMP ASSEMBLY. The unit pump is a multi-component assembly serving to circulate water through the process system. The pump will increase the system pressure between 35 - 50 PSI over the plant water supply pressure. The pump is driven by an electrical motor.

1. **Pump casing.** The pump casing is an exclusive design. The casing is cast of iron and flanged to accept the heater/discharge and cooling tanks. The casing is the support element in the pump/motor assembly and is secured to the unit base (figure 6.1A).

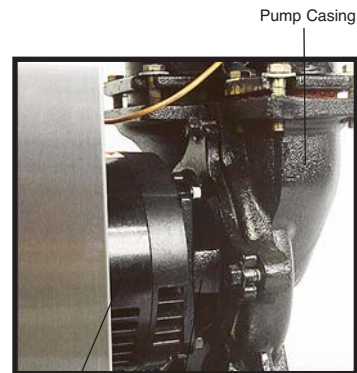

2. **Pump adapter.** The pump adapter is the mating element between the pump casing the electric motor. The adapter is machined to accept the pump seal flush line. The stationary pump seal member is set in the seal cavity of the pump adapter (figure 6.1A).

3. **Electrical motor.** The electric motor is a dual voltage, 3 phase, ODP motor. The motor serves to turn the pump impeller creating process flow (figure 6.1A).

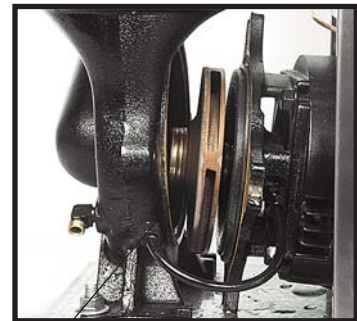

4. **Impeller.** The impeller is custom designed for the unit and creates the higher flow (gpm) from standard HP ratings (figure 6.1B).

5. **Pump Seal.** The pump seal prevents water leakage from the pump adapter. The seal is made up of three items: The stationary member (seated in the seal cavity), the rotating member (placed on the motor shaft) and the tension spring (figure 6.1C shows the stationary member only).



6. Pump seal flush. The pump seal flush is a flow diverter which serves to “cleanse” the pump seal assembly of debris which may lodge on the seal and create a leak (figure 6.1D).

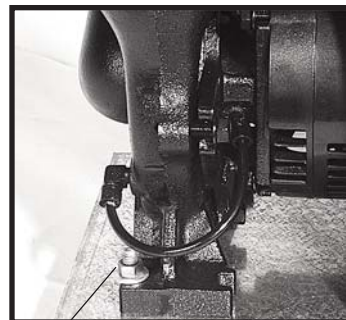

Seal flush tube

Figure 6.1D

B. HEATER. The heater is a dual voltage, flange mounted immersion heater set in the pump discharge cylinder. The heater elements have a stainless steel sheath. Electrical supply to the heater is provided via a mercury contactor (figure 6.1E).

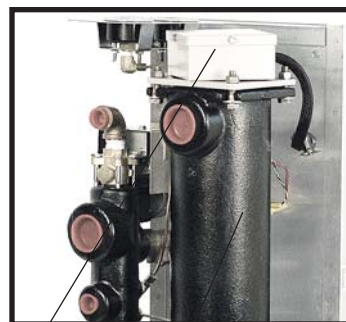

Heater

Discharge tank

Figure 6.1E

C. HEATER/PUMP DISCHARGE CYLINDER. The heater/pump discharge cylinder is a custom cast tank. The tank is flanged mounted to the pump casing. Reinforced machined bosses accept the “to process/high temperature limit” sensor probe and the “to process” connection (figure 6.1E).

D. COOLING CYLINDER. The cooling cylinder is a custom cast tank. The tank is flanged mounted to the pump casing. Reinforced machined bosses accept the pressure relief valve, the “from process” pressure gauge and pressure switch capillary connector, AVT™ modulating cooling valve, the “water supply connection” and the “from process” connection (figure 6.1F).

AVT valve

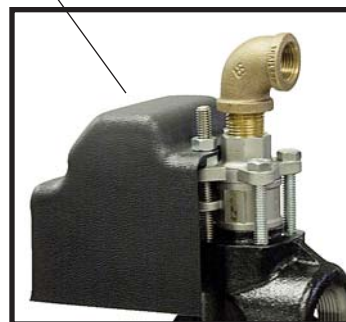

Figure 6.1F

E. PRESSURE RELIEF VALVE. The pressure relief valve is a 150 psi relief valve serving to discharge excessive unit pressure to atmosphere. The valve can be manually activated by lifting the actuating lever (figure 6.1F).

F. AVT™ VALVE. The AVT™ valve is a patented Temptek design using a motor/gearbox assembly to open in minute increments from 0 to 100% a custom ball valve assembly. The AVT™ valve is controlled by custom programming of the instrument (figure 6.1F).

G. PRESSURE GAUGES. “To” and “from” process pressure gauges display the system pressure. “To process” pressure originates at the heat/pump discharge cylinder. “From process” pressure originates

at the cooling cylinder. The gauges accurately display system pressures from 0 to 160 PSI (figure 6.1G).

H. CASTERS. The unit is mounted on 4 swivel ball bearing casters. The casters allow the unit to be portable and easily move from location to location.

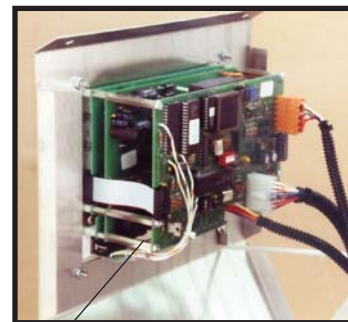

Figure 6.1G

I. STAINLESS STEEL CABINTRY. The stainless steel cabinetry prevents unsightly rust and metal decay. The electrical cabinet cover is hinged. The unit base is made of pressed steel with galvanized zinc coating. The lift off access panel is secured to the unit base by 5 screws (figure 6.1G).

6.2 ELECTRICAL SYSTEM

A. INSTRUMENT. The instrument is a custom designed and assembled microprocessor controller. The instrument is mounted to the electrical panel cover. The instrument controls the cycling of the heater, motor pump and AVT™ valve. System and setpoint temperatures are displayed continually. System parameters are programmable (figure 6.2A).



Typical instrument with service connections removed

Figure 6.2A

B. TRANSFORMER. The transformer supplies 110 volts to the controlling instrument (figure 6.2B).

C. PUMP MOTOR CONTROLLER. The electrical motor is engaged when the motor starter contacts close, on command by the instrument. The electric motor is protected from excessive amperage by a set of thermal overload relays, which open when excessive amperage “heats” the overloads and the relay opens (figure 6.2B).

D. HEATER CONTACTOR. The heater contactor is a solid state contactor. On command from the instrument, the contactor will close and voltage will be supplied to the heater (figure 6.2B).

Transformer Heater Contactor Pump Motor Controller



Pressure switch

Figure 6.2B

E. PRESSURE SWITCH. The electric panel mounted pressure switch will close when sufficient pressure is supplied to the unit (20 psi). A closed pressure switch will consent the control circuit to the instrument controller to allow process operations (figure 6.2B).

F. SENSOR PROBES. The unit uses two sensor probes. The “to process” temperature sensor and the “high temperature limit” safety switch” are housed in the same assembly and mounted in the heater/pump discharge tank (figure 6.2C). The “from process” probe is mounted in the suction tank.

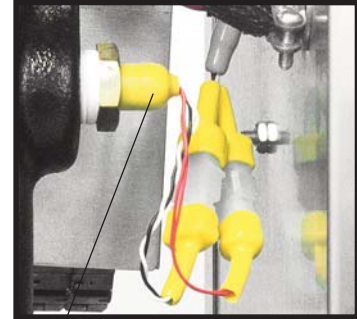

Sensor probe and high temperature limit

Figure 6.2C

G. POWER CORD. The supplied power cord is factory installed to the unit. The power cord is a 3 conductor with 1 ground wire sized for the unit and 10' in length.

THIS PAGE INTENTIONALLY BLANK

7.0 RELATED DRAWINGS

- 7.1** SENTRA PHYSICAL
- 7.2** SENTRA ELECTRICAL
- 7.3** SENTRA CIRCUIT SCHEMATIC
- 7.4** SENTRA REGULATOR/BYPASS INSTALLATION
- 7.5** SENTRA DUAL ZONE DOLLY
- 7.6** SENTRA STACKING RACK



7.1 PHYSICAL

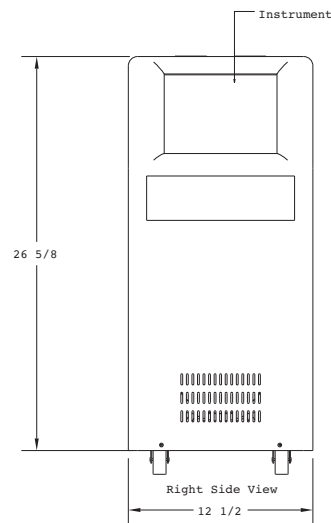
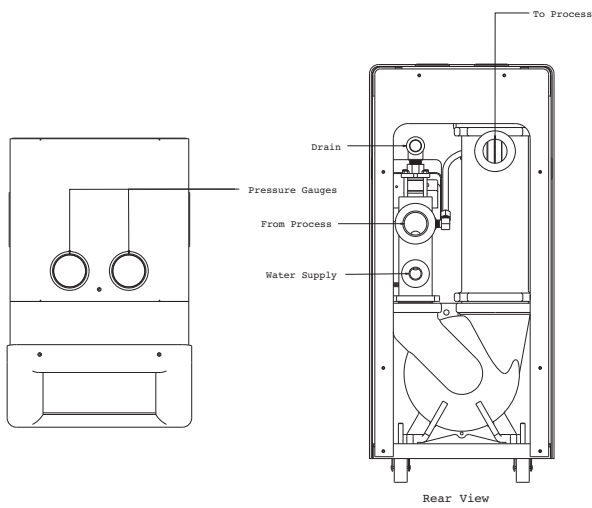
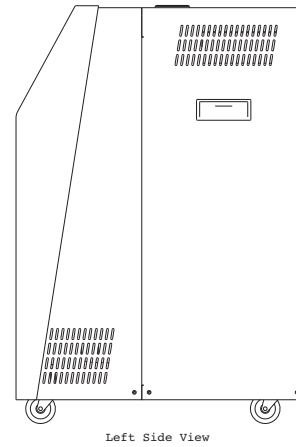
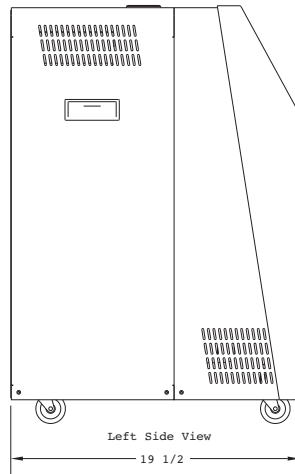
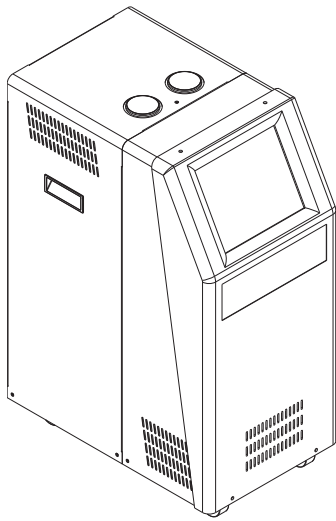

7.2 TYPICAL ELECTRICAL

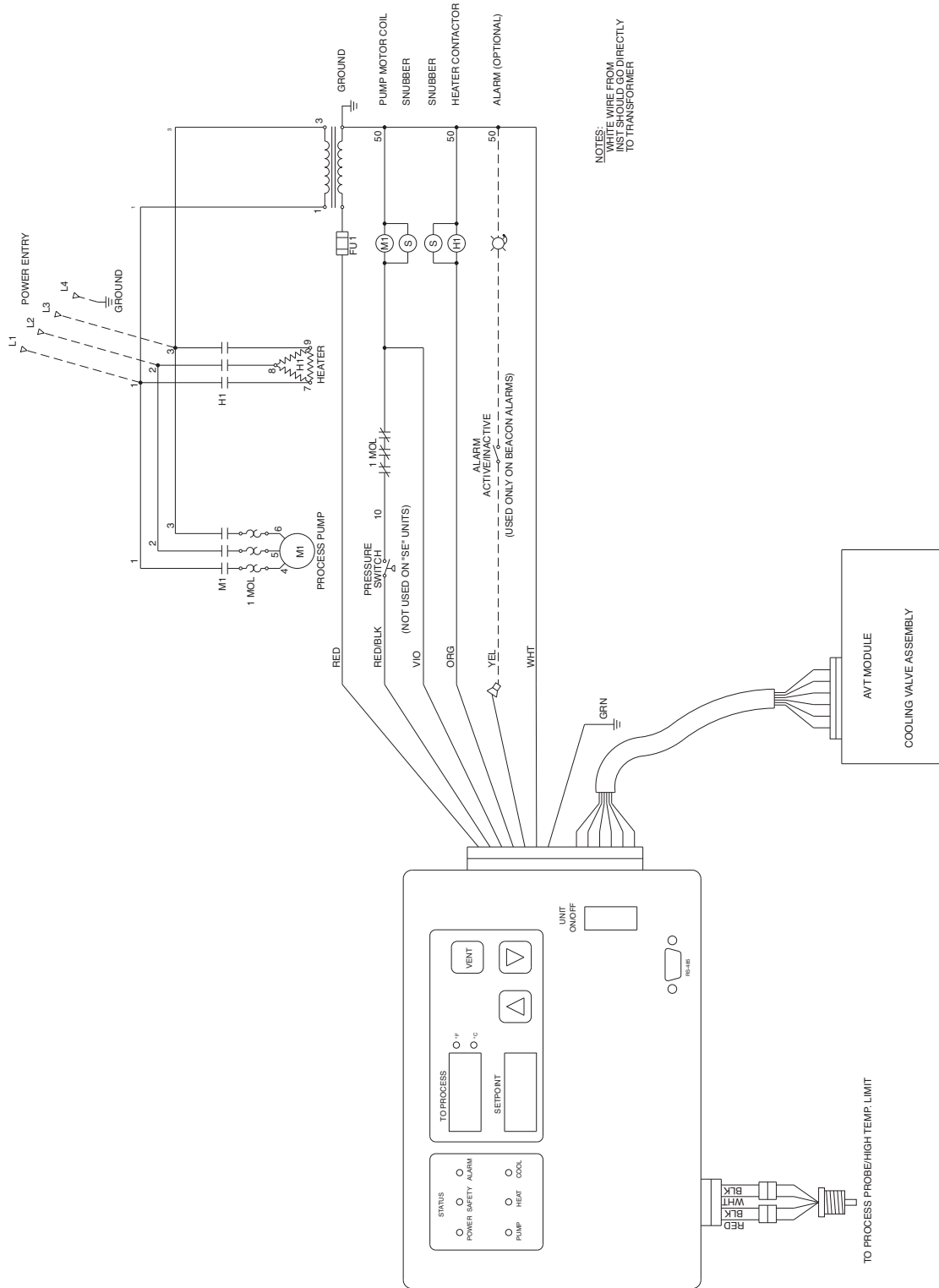

Provided for display purposes only. Refer to electrical drawing supplied with unit for details.



7.3 CIRCUIT SCHEMATIC

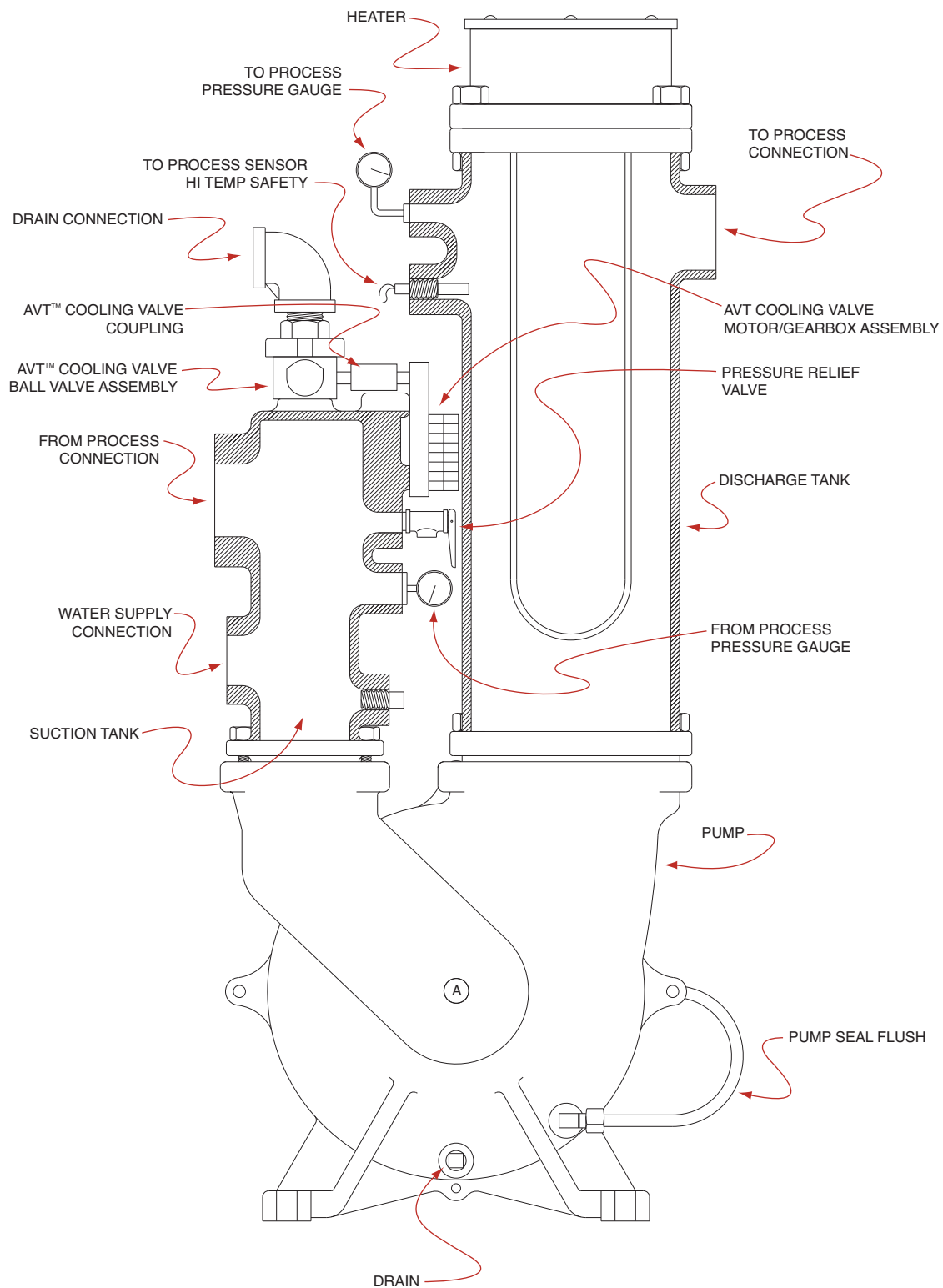

7.4 REGULATOR/BYPASS INSTALLATION

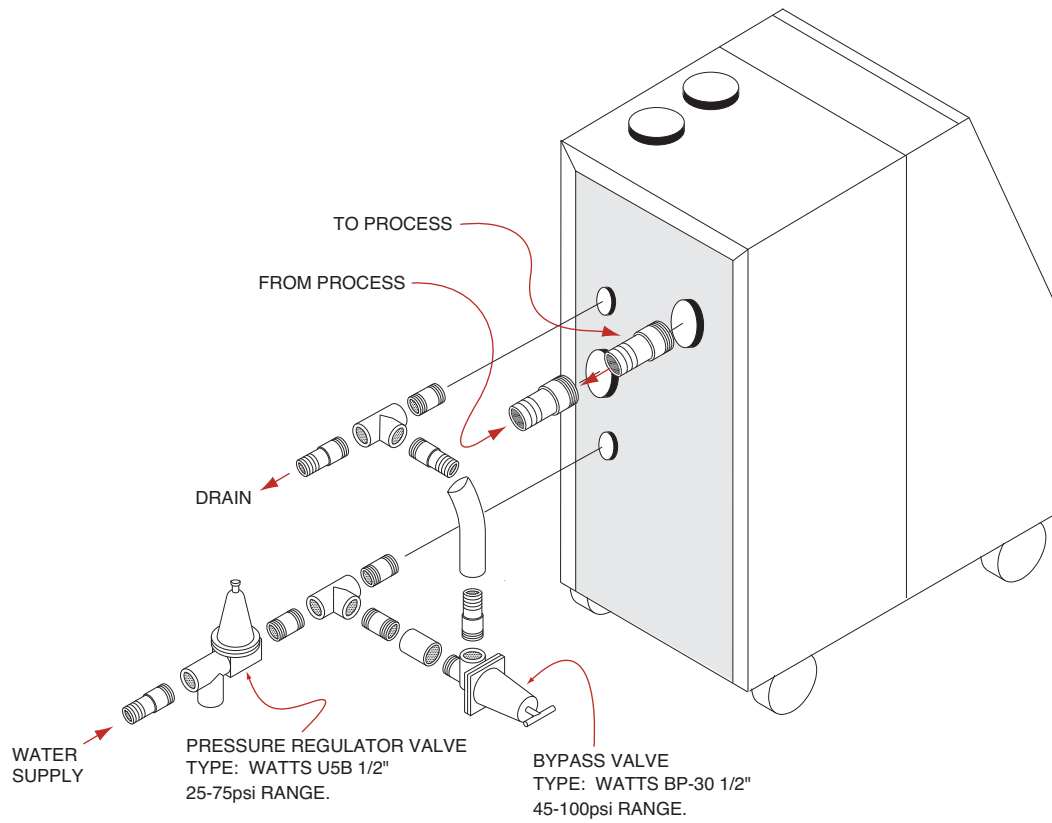

7.5 DUAL ZONE DOLLY

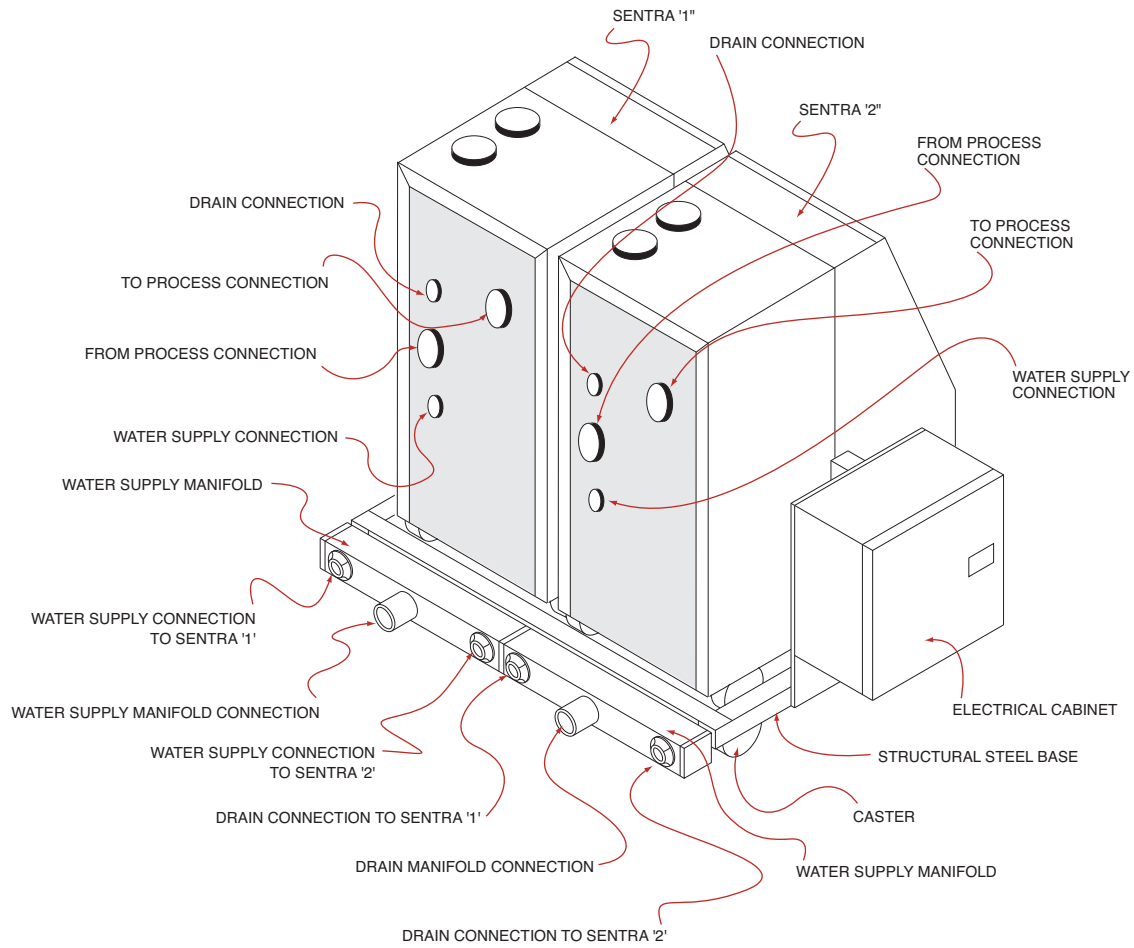

7.6 STACKING RACK

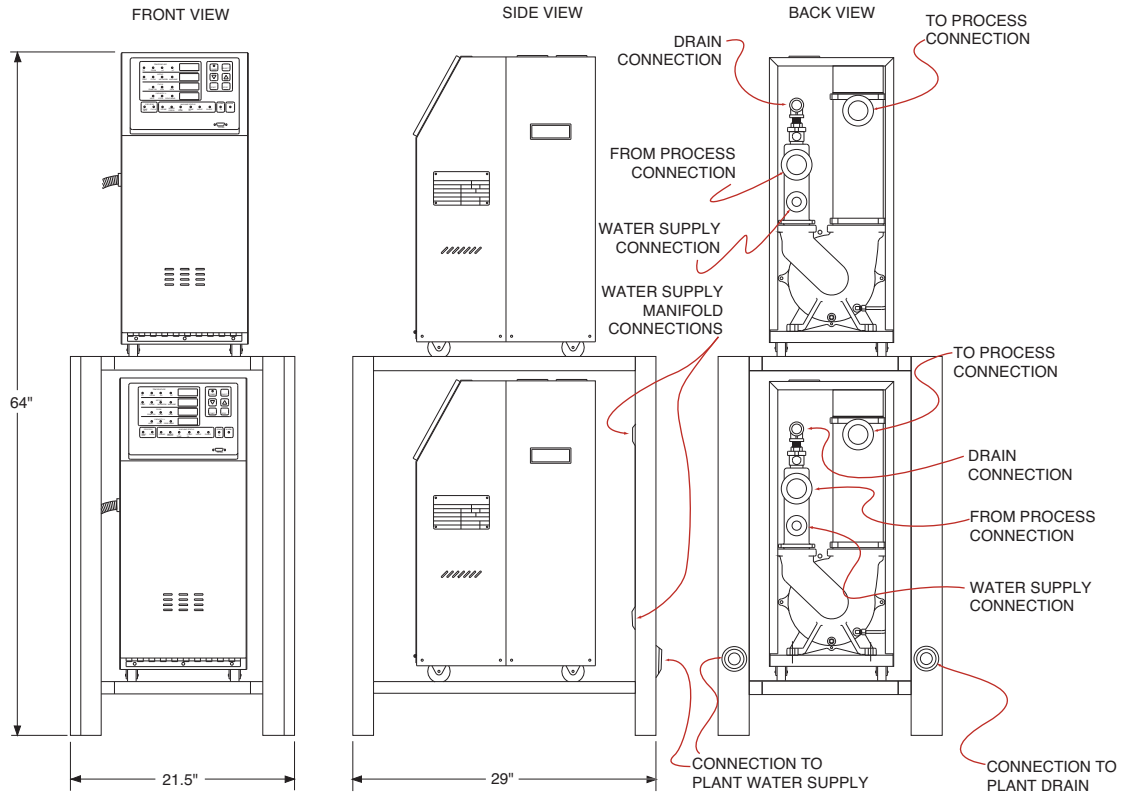

THIS PAGE INTENTIONALLY BLANK

8.0 APPENDIX

- 8.1** SPECIFICATIONS
- 8.2** MODEL # AND SUFFIX CODING
- 8.3** INTERPRETATION OF PROCESS PRESSURE GAUGES
- 8.4** OPERATION OF MOLD PURGE
- 8.5** CLOSED CIRCUIT OPERATION
- 8.6** SPI COMMANDS
- 8.7** COMMUNICATION CABLE
- 8.8** OPTIONAL ALARM OPERATION
- 8.9** AVT™ VALVE COMPONENTS
- 8.10** AS5 PUMP PARTS LIST - 1/2 HP TO 1 HP
- 8.11** AS5 PUMP PARTS LIST - 1.5 HP TO 3 HP
- 8.12** PARTS LIST - LX INSTRUMENT



8.1 SPECIFICATIONS

		620	635	645	665	675	680	1020	1035	1045	1065	1075	1080	1090	10100	1620	1635	1645	1665	
Heater¹	kW	6	6	6	6	6	6	10	10	10	10	10	10	10	10	16	16	16	16	
Process Pump	HP	1/2	3/4	1	1 1/2	2	3	1/2	3/4	1	1 1/2	2	3	5	7 1/2	1/2	3/4	1	1 1/2	
	GPM	20	35	45	62	75	80	20	35	45	62	75	80	90	100	20	35	45	62	
	PSI	30	30	30	30	30	30	30	30	30	30	30	30	30	34	54	30	30	30	30
Full Load Amperage	230 volt	17.0	17.8	18.6	20.2	21.8	24.6	27.0	27.8	28.6	30.2	31.8	34.6	40.3	47.1	42.0	42.8	43.6	45.2	
	@3ø/60hz²	460 volt	8.5	8.9	9.3	10.1	10.9	12.3	13.5	13.9	14.3	15.1	15.9	17.3	20.2	23.5	21.0	21.4	21.8	22.6
Dimensions (inches)	Height	28 1/4	28 1/4	28 1/4	28 1/4	28 1/4	28 1/4	28 1/4	28 1/4	28 1/4	28 1/4	28 1/4	28 1/4	28 1/4	44	44	28 1/4	28 1/4	28 1/4	28 1/4
	Width	12 1/2	12 1/2	12 1/2	12 1/2	12 1/2	12 1/2	12 1/2	12 1/2	12 1/2	12 1/2	12 1/2	12 1/2	12 1/2	16	16	12 1/2	12 1/2	12 1/2	12 1/2
	Depth	19 1/2	19 1/2	19 1/2	19 1/2	19 1/2	19 1/2	19 1/2	19 1/2	19 1/2	19 1/2	19 1/2	19 1/2	19 1/2	24	24	19 1/2	19 1/2	19 1/2	19 1/2
Connections (inches)	T/F³	1 1/4	1 1/4	1 1/4	1 1/4	1 1/4	1 1/4	1 1/4	1 1/4	1 1/4	1 1/4	1 1/4	1 1/4	1 1/4	2	2	1 1/4	1 1/4	1 1/4	1 1/4
	S/D⁴	1/2	1/2	1/2	1/2	1/2	1/2	1/2	1/2	1/2	1/2	1/2	1/2	1/2	1/2	1/2	1/2	1/2	1/2	1/2
Weight (pounds)	Shipping⁵	195	200	205	205	210	220	198	200	208	208	213	223	275	290	200	205	210	210	

		1675	1680	1690	16100	2435	2445	2465	2475	2480	2490	24100	3435	3445	3465	3475	3480	3490	34100
Heater¹	kW	16	16	16	16	24	24	24	24	24	24	24	34	34	34	34	34	34	34
Process Pump	HP	2	3	5	7 1/2	3/4	1	1 1/2	2	3	5	7 1/2	3/4	1	1 1/2	2	3	5	7 1/2
	GPM	75	80	90	100	35	45	65	75	80	90	100	35	45	65	75	80	90	100
	PSI	30	30	34	54	30	30	30	30	30	34	54	30	30	30	30	30	34	54
Full Load Amperage	230 volt	46.8	49.6	55.4	62.2	63.1	63.9	65.5	67.1	69.9	75.5	82.3	88.2	89.0	90.6	92.2	95.0	100.6	107.4
	@3ø/60hz²	460 volt	23.4	24.8	27.7	31.1	31.6	32.0	32.8	33.6	35.0	37.8	41.2	44.1	44.5	45.3	46.1	47.5	50.3
Dimensions (inches)	Height	28 1/4	28 1/4	44	44	44	44	44	44	44	44	44	44	44	44	44	44	44	44
	Width	12 1/2	12 1/2	16	16	16	16	16	16	16	16	16	16	16	16	16	16	16	16
	Depth	19 1/2	19 1/2	24	24	24	24	24	24	24	24	24	24	24	24	24	24	24	24
Connections (inches)	T/F³	1 1/4	1 1/4	2	2	1 1/4	1 1/4	1 1/4	1 1/4	1 1/4	2	2	1 1/4	1 1/4	1 1/4	1 1/4	1 1/4	2	2
	S/D⁴	1/2	1/2	1/2	1/2	1/2	1/2	1/2	1/2	1/2	1/2	1/2	1/2	1/2	1/2	1/2	1/2	1/2	1/2
Weight (pounds)	Shipping⁵	220	225	285	300	270	275	280	285	290	295	310	280	285	290	295	300	305	320

Notes: 1. Derate heater output by 25% for 208/3/60 operation. 2. Consult factory for 50hz operations. 3. T - to process; F - from process. 4. S - water supply; D - drain. 5. Approximate unit shipping weight.



8.2 MODEL # AND SUFFIX CODING

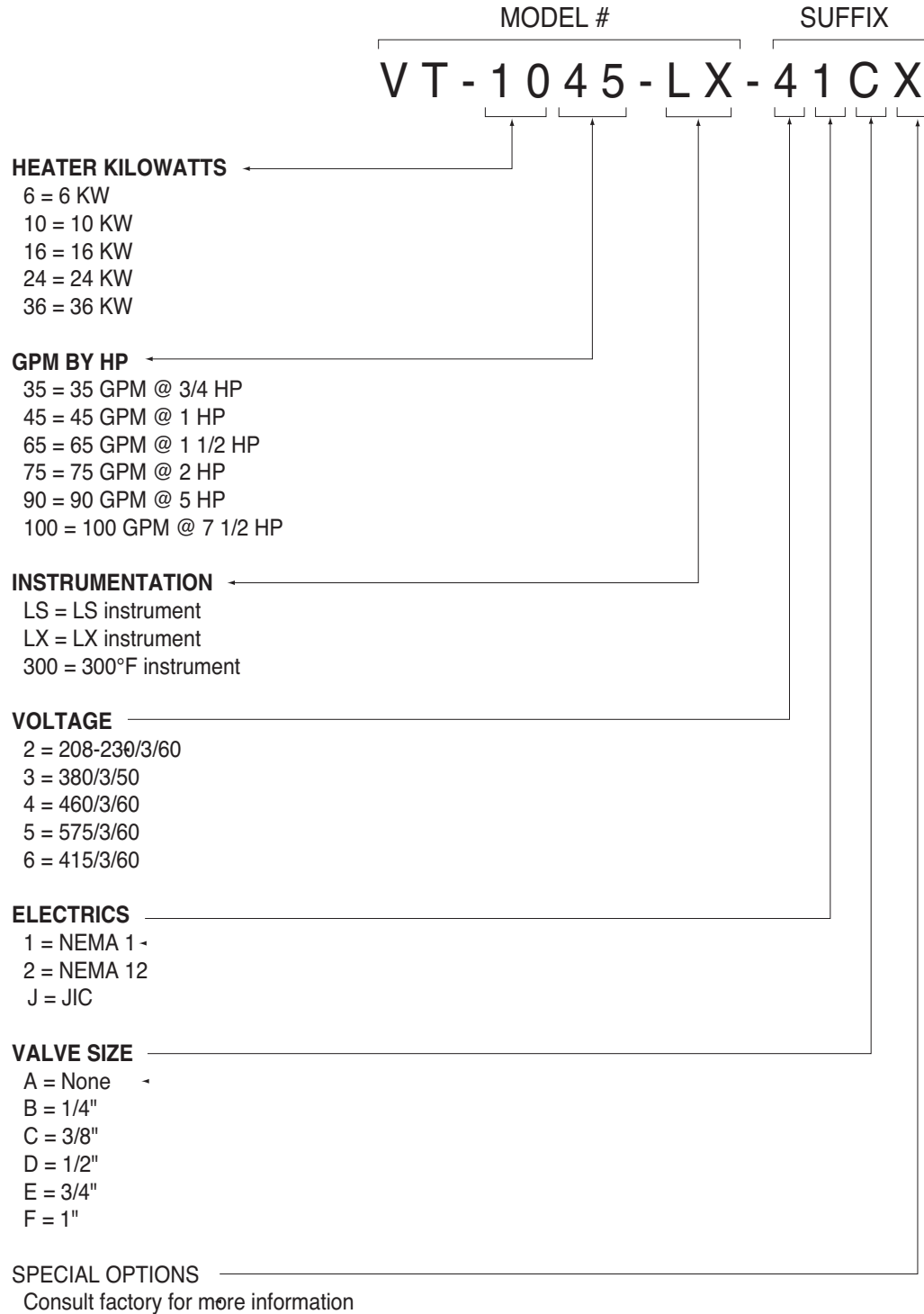

8.3 INTERPRETATION OF PROCESS PRESSURE GAUGES

A. READ AVAILABLE WATER PRESSURE AT UNIT'S LOCATION. When a temperature control unit is attached to the process with the water supply on and the pump off, both gauges will read the water supply pressure at the unit's location (figure 7.3A).



Pressure gauges

Figure 7.3A

B. READ PRESSURE DROP ACROSS PROCESS (ΔP). With the pump on, the "to process" pressure gauge will rise to read the sum of the water supply pressure and pump generated pressure. The "from process" pressure gauge reads the effect of water supply pressure and pump suction pressure. The difference between the to and from process gauges is the pump generated circulating pressure... which is also equal to the pressure drop across the process.

C. PUMP ROTATION INDICATION. If the pump is running, and both gauges are "close" to same value, it is likely that the pump is rotating backward, or the pump is generating such a high flow that an overload condition will result.

D. PUMP MOTOR OVERLOAD CONDITION. If the ΔP is low with the pump rotating correctly, then the flow rate is high, which probably will result in a motor overload. Refer to the representative pump curve below.

E. WATER HAMMER (COMPETITIVE SOLENOID VALVE UNITS). On competitive mold temperature controllers, when ΔP gauges are supplied, the water hammer effect of on/off solenoid valves can be seen. When the solenoid valve is open, both to and from process pressure gauges will fall as the system depressurizes. When the valve closes, there will be a momentary spike that will be seen on both pressure gauges, then they will settle back to normal ΔP values. This spike is called "water hammer".

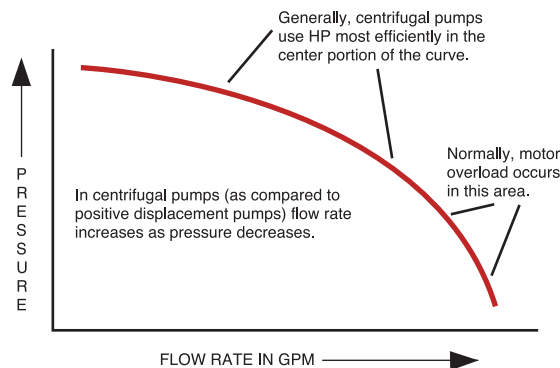

8.4 OPERATION OF MOLD PURGE

- A.** Temptek supplies an optional **MOLD PURGE** kit for temperature control units. The mold purge kit contains several solenoid valves and check valves. When activated and supplied with compressed air, the mold purge kit will expel process water from the mold to the central water supply or drain. Temptek mold purge kits are supplied as a factory installed option or a field retrofitted kit.
- B. The operation of the mold purge is as follows (see illustration)**

1. Stop the pump, maintain electrical power to unit.
2. Close the water supply ball valve.
3. Connect a regulated air supply to mold purge compressed air connection.

Note: Air supply should be regulated approximately 10 PSI above drain line pressure.

4. Activate mold purge with button located on electrical cabinet.
5. When water is purged disconnect air supply.
6. Depress and hold vent button (approximately 30 seconds to release air pressure).
7. Disconnect power to unit.

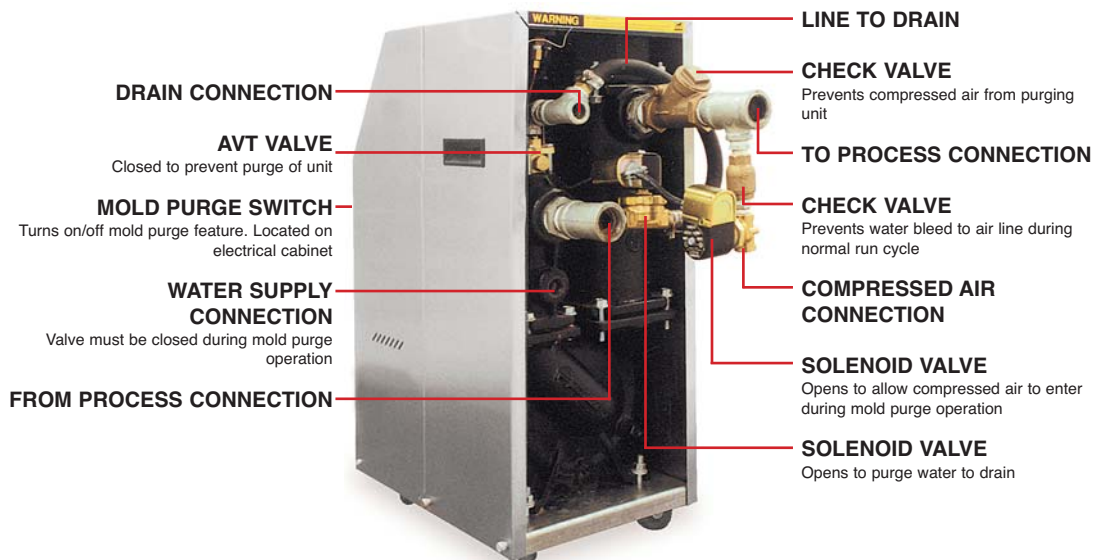
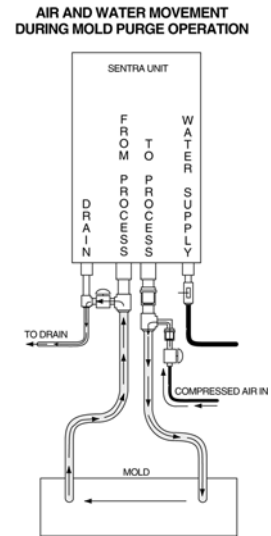

8.5 CLOSED CIRCUIT OPERATION

- A. Standard mold temperature controllers are supplied as 'open-circuit' units. 'VT' units can be used on 'closed-circuit' applications with the installation of the 'SE' kit.
- B. Factory installed 'SE' kits place a heat exchanger into system to separate the cooling water loop from the process circulation loop. Cooling water from plant water supplies circulate only through the 'tube' side of the heat exchanger. Process water circulates through the 'shell' side of the heat exchanger.
- C. To control process water temperature, a microprocessor controlled AVT™ modulating valve is installed on the heat exchanger drain line.
- D. The closed circuit kit will add 10" to the overall height of the unit. The width and depth do not change, although the length of connection hose extending from the back of the unit must be accounted for.

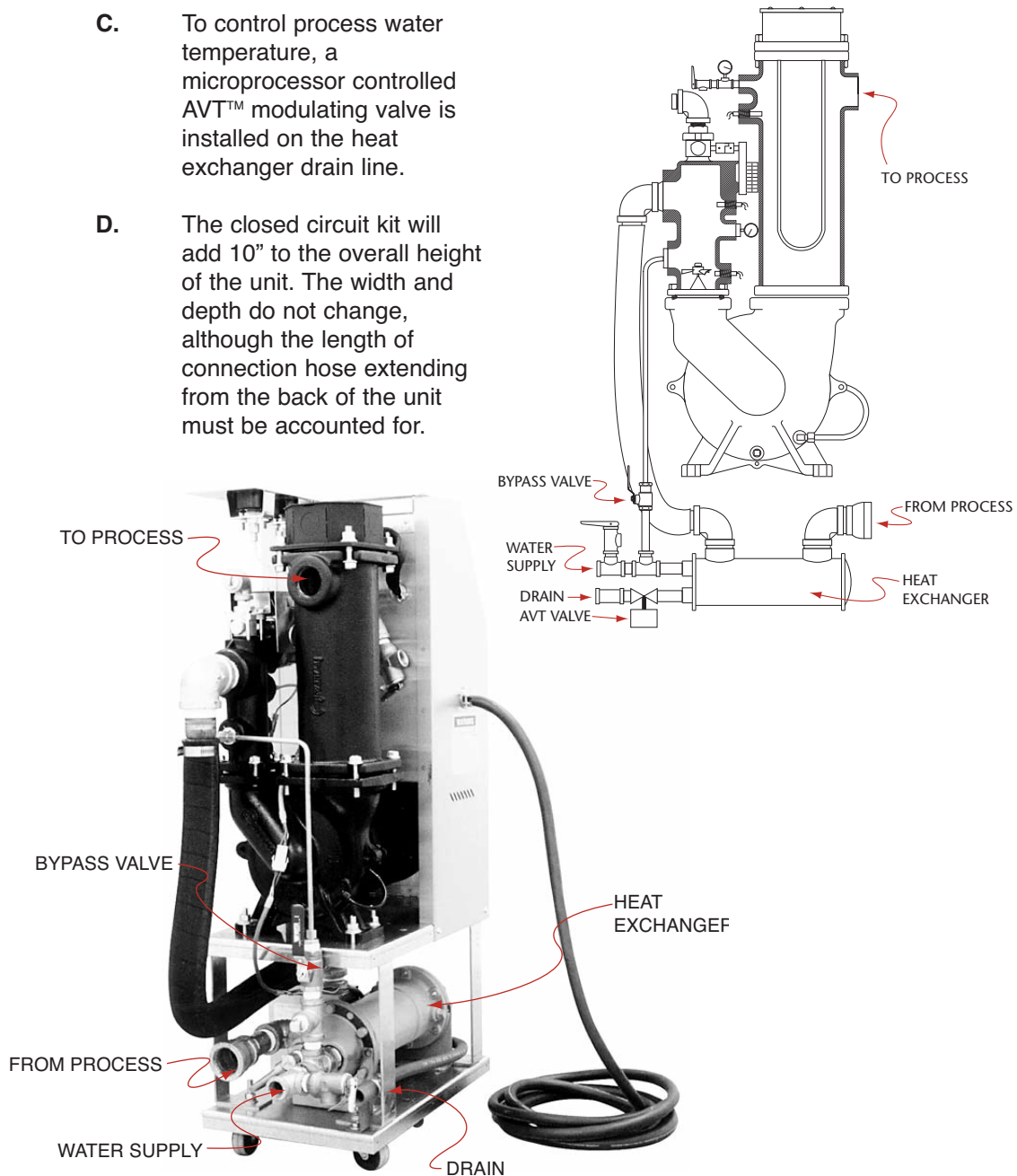

8.6 SPI COMMANDS

- A. INTRODUCTION:** In 1987 a group of member companies of the Society of the Plastics Industries began development of a communication protocol for use by their processing and auxiliary equipment. Their goal was to allow the exchange of information between various pieces of equipment from different manufacturers to be simple and reliable. The result of their work was released in 1990 and has made the interconnection of equipment much easier and straightforward. There are now over 40 companies that offer the SPI Protocol in their products. This document details the implementation of the SPI Protocol available in the SENTRA 'SK' temperature controllers and MAXIMUM 'MK' portable chillers with HE instruments.
- B. PROTOCOL BASICS:** The SPI Protocol is described by a 2 part specification. The largest portion of the SPI Protocol specification deals with how basic information is exchanged between equipment. The second part of the specification details the actual pieces of information exchanged using the protocol. Items such as Process Temperature, Process Setpoint and Process Status are detailed in this part. This FYI will list the commands that are supported by TEMPTEK equipment.
- C. EQUIPMENT SETUP:** The setup of equipment to be connected in an SPI Protocol network is simple. Each device must have a unique address for its device type and it must use the same data transfer rate as the other pieces of equipment in the network. There are many acceptable ways used to 'set' the device address and data rate. TEMPTEK equipment provides access to the information via the front panel operators and displays. Other manufacturers may use internal DIP switches or jumpers.

A typical cell may be configured as follows:

Data Transfer Rate: 9600 bits per second (bps)
Mold Temperature Controller (Qty 2): Addresses 1 and 2
Chiller (Qty 1): Address 1

Note in the above example that different device types may have the same address. This is because the SPI Protocol uses the device type as part of its internal address.

- D. NETWORK TROUBLESHOOTING:** Troubleshooting a network is best done by verifying the setup of each piece of equipment and insuring that the network is installed with the correct electrical interconnection. Here are some basic things to do if equipment isn't 'talking' as expected.
1. Verify that each piece of equipment is properly grounded to its power source.



2. Inspect cables inside and outside the electrical cabinet. Repair or replace as necessary. The cable scheme used by most manufacturers allows the communication signals to 'pass through' each piece of equipment. Therefore, when a piece of equipment is disconnected from the middle of the network, all the equipment 'after' that one will be disconnected, too. If a piece of equipment is being permanently removed, the device cables should be rearranged at the molding machine to reconnect the other equipment.
3. Check the Data Transfer Rate and Address of each piece of equipment. For example, if both Temperature Controllers have the same address, they will both try to 'talk' at the same time and garble each other's data.
4. Verify the network is properly terminated and that it is configured as a 'multi-drop'. This is best achieved by following the molding machine manufacturer's installation instructions and use extension cables provided by them or us.
5. Attach each device, singly, to the molding machine and see if it 'talks'. Add additional devices until a problem is seen.

SENTRA 'SK' Temperature CONTROLLER SPI COMMANDS

POLL		SELECT		COMMAND	DESCRIPTION
C1	C2	C1	C2		
20	20	20	21	Echo	Controller integrity command
20	20			Version	Controller version command
20	30	20	31	Setpoint	Desired process temperature
20	32	20	33	High temp	Hi temperature deviation alarm
20	34	20	35	Low temp	Low temperature deviation alarm
20	36	20	37	Flow Alarm	Low flow alarm setpoint*
20	40			Status Process	

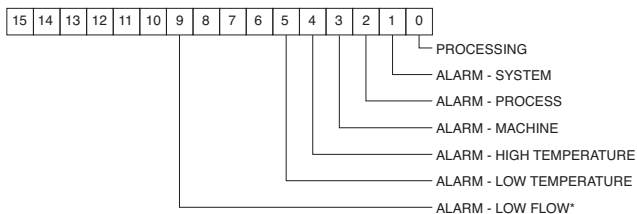

POLL SELECT
C1 C2 C1 C2 COMMAND DESCRIPTION
 20 42 Status Machine 1

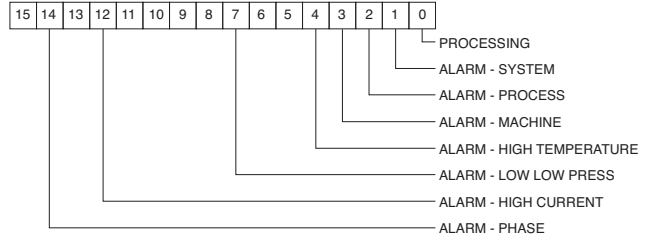

POLL SELECT
C1 C2 C1 C2 COMMAND DESCRIPTION
 20 44 Status Machine 2

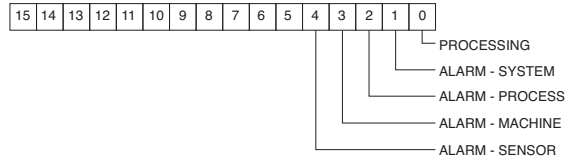

POLL SELECT
C1 C2 C1 C2 COMMAND DESCRIPTION
 20 48 20 49 Machine

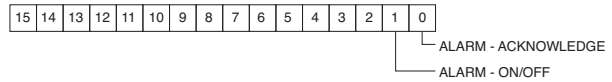

POLL SELECT
C1 C2 C1 C2 COMMAND DESCRIPTION
 20 4A 20 4B Protected mode - machine

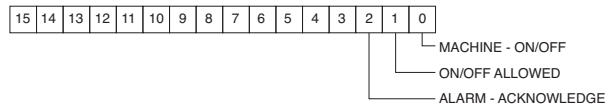

POLL SELECT
C1 C2 C1 C2 COMMAND DESCRIPTION
 20 70 Temperature to process
 20 72 Temperature from process*
 20 78 Flow rate from unit GPM*
 20 E0 Blanket Poll
 Returns: 20 30 Setpoint
 20 32 High alarm deviation
 20 34 Low alarm deviation
 20 40 Status process
 20 70 To process temperature



8.7 COMMUNICATIONS CABLE

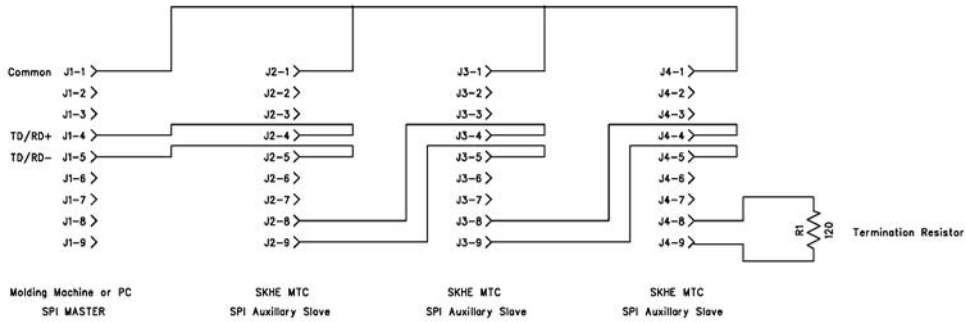

VERSION 3.01 MACHINE CONNECTIONS

PRIMARY MACHINE CONNECTIONS

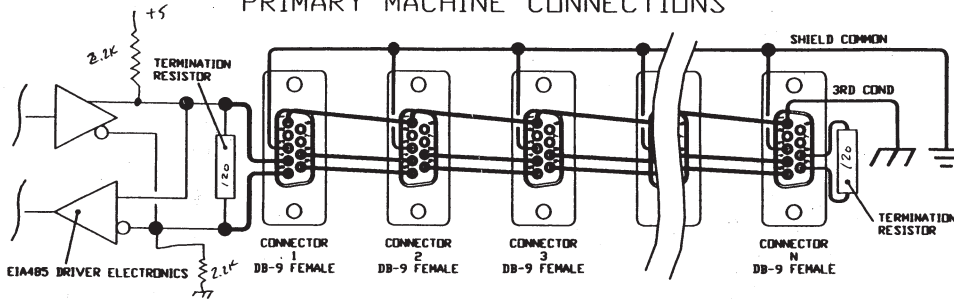

AUXILIARY MACHINE CONNECTIONS

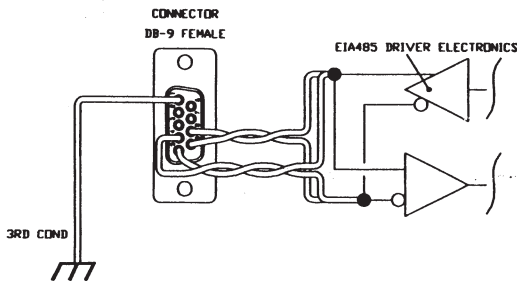

JUMPER PLUG

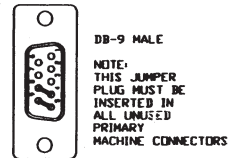

8.8 OPTIONAL ALARM OPERATION

- A. The mold temperature control unit is standard with a 110 volt AC alarm output. The alarm output can be connected to customer provided alarm annunciation, plant-wide monitoring system or optional annunciation provided by **Temptek**.
- B. **BEACON ALARMS** used when both visual and audible alarm annunciation is needed. The **Temptek** beacon is an integral light and buzzer assembly to provide high visibility in a busy, noisy shop. The beacon will signal until the alarm condition is acknowledged by the operator.
- C. **AUDIBLE ALARMS** provide a loud signal when an alarm condition is present. The **Temptek** audible alarm is mounted on the from cover of the unit.

CONDITIONS THAT TRIGGER AN ALARM OUTPUT ON MOLD TEMPERATURE CONTROLLERS

CONDITION	CONTROLLER	
	LS	LX
Incorrect 3Ø power entry	No	No
Pump overload tripped	No	Yes
High temperature fault	No	Yes
Water supply pressure fault	No	Yes
Temperature deviation	No	Yes
AVT valve malfunction	No	Yes
Sensor probe malfunction	No	Yes

BEACON AND AUDIBLE ALARMS ARE SILENCED DURING AN ALARM CONDITION BY PRESSING THE START BUTTON ON MICROPROCESSOR CONTROLLER



8.9 AVT™ VALVE COMPONENTS

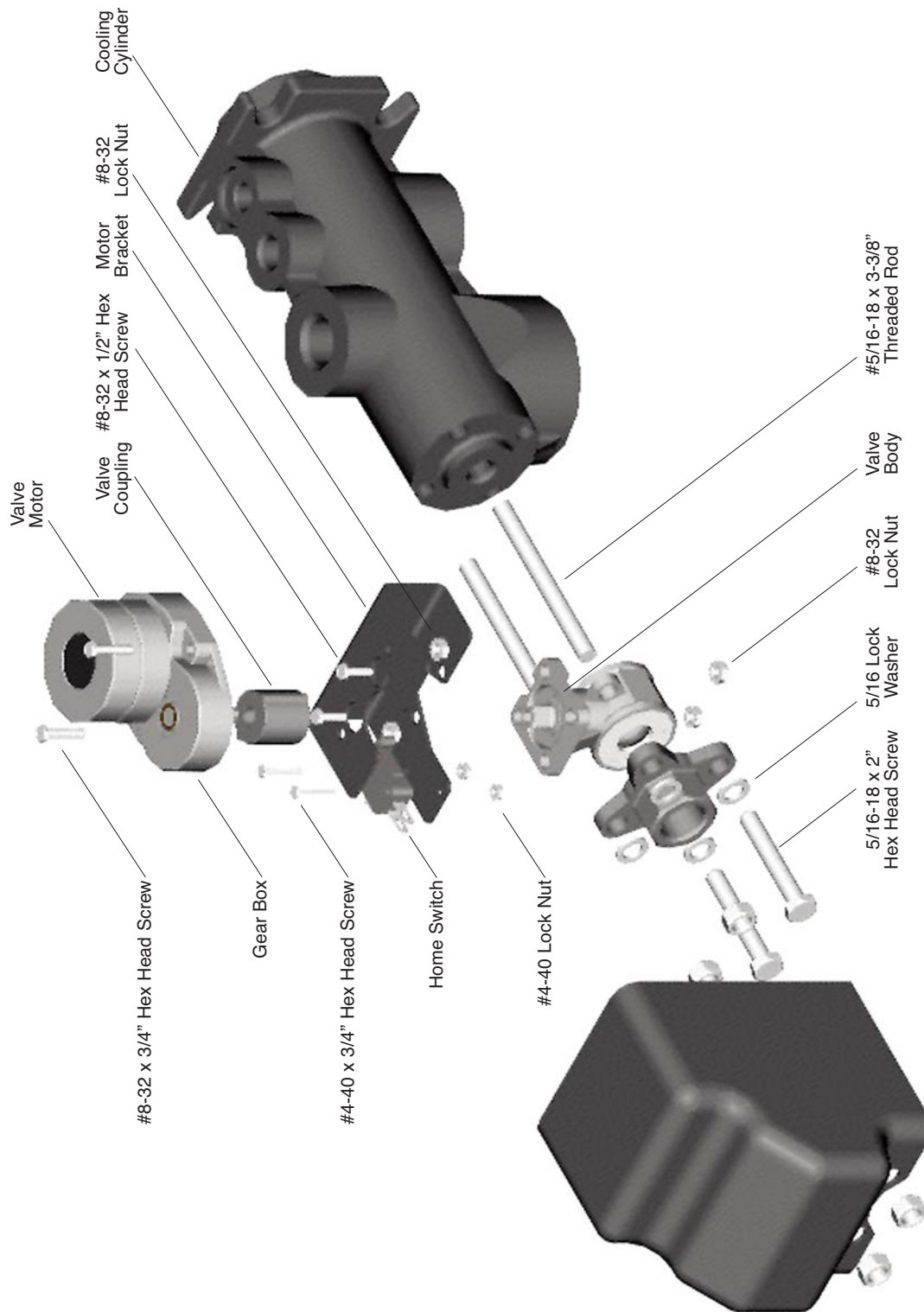

8.10 AS5 PUMP PARTS LIST - 1/2 HP TO 1 HP

PART #	DESCRIPTION
6206995	MOTOR/PUMP ASSEMBLY 1/2HP AS5 2/4/3/60
414	Adapter - iron C2-4551 AS5
771599	Pump case - iron D2-1839 AS5
3444400	Tank gasket 2-3/8" A-9159 AS5
3444401	Tank gasket 4-1/2" A2-8748 AS5
4310601	Impeller B2-5264 4.37" AS5
4757861	Motor AE5/AS5/A5W 1HP #S-2771R
5486522	Nut S-4989 AS5
5622271	O-ring Case S-5091 AS5
6490000	Shaft seal 101-173 5/8 EPT
6491000	Shaft seal EPT/Ceramic 4949 AE5/AS5
6207000	MOTOR/PUMP ASSEMBLY AS5 3/4HP ODP 230/460
414	Adapter - iron C2-4551 AS5
771599	Pump case - iron D2-1839 AS5
3444400	Tank gasket 2-3/8" A-9159 AS5
3444401	Tank gasket 4-1/2" A2-8748 AS5
4310602	Impeller B2-5264 4.5" AS5
4757862	Motor AE5/AS5/A5W 3/4HP #S-2772R
5486522	Nut S-4989 AS5
5622271	O-ring Case S-5091 AS5
6490000	Shaft seal 101-173 5/8 EPT
6491000	Shaft seal EPT/Ceramic 4949 AE5/AS5
6207010	MOTOR/PUMP ASSEMBLY AS5 1HP AS5 2/4/3/60
414	Adapter - iron C2-4551 AS5
771599	Pump case - iron D2-1839 AS5
3444400	Tank gasket 2-3/8" A-9159 AS5
3444401	Tank gasket 4-1/2" A2-8748 AS5
4310603	Impeller B2-5264 4.75" AS5
4757863	Motor AE5/AS5/A5W 1 HP #S-2773R
5486522	Nut S-4989 AS5
5622271	O-ring Case S-5091 AS5
6490000	Shaft seal 101-173 5/8 EPT
6491000	Shaft seal EPT/Ceramic 4949 AE5/AS5



8.11 AS5 PUMP PARTS LIST - 1.5 HP TO 3 HP

PART #	DESCRIPTION
6207020	MOTOR/PUMP ASSEMBLY AS5 1.5HP 2/4/3/60
414	Adapter - iron C2-4551 AS5
771599	Pump case - iron D2-1839 AS5
3444400	Tank gasket 2-3/8" A-9159 AS5
3444401	Tank gasket 4-1/2" A2-8748 AS5
4310604	Impeller B2-5264 5.06" AS5
4757864	Motor AE5/AS5/A5W 1-1/2HP #S-2774R
5486522	Nut S-4989 AS5
5622271	O-ring Case S-5091 AS5
6490000	Shaft seal 101-173 5/8 EPT
6491000	Shaft seal EPT/Ceramic 4949 AE5/AS5
6207030	MOTOR/PUMP ASSEMBLY AS5 2HP 2/4/3/60
414	Adapter - iron C2-4551 AS5
771599	Pump case - iron D2-1839 AS5
3444400	Tank gasket 2-3/8" A-9159 AS5
3444401	Tank gasket 4-1/2" A2-8748 AS5
4310605	Impeller B2-5264 5.25" AS5
4757865	Motor AE5/AS5/A5W 2HP #S-2775R
5486522	Nut S-4989 AS5
5622271	O-ring Case S-5091 AS5
6490000	Shaft seal 101-173 5/8 EPT
6491000	Shaft seal EPT/Ceramic 4949 AE5/AS5
6207040	MOTOR/PUMP ASSEMBLY 3HP AS5 2/4/3/60
414	Adapter - iron C2-4551 AS5
771599	Pump case - iron D2-1839 AS5
3444400	Tank gasket 2-3/8" A-9159 AS5
3444401	Tank gasket 4-1/2" A2-8748 AS5
4310605	Impeller B2-5264 5.25" AS5
4757866	Motor AE5/AS5/A5W 3HP #4551R
5486522	Nut S-4989 AS5
5622271	O-ring Case S-5091 AS5
6490000	Shaft seal 101-173 5/8 EPT
6491000	Shaft seal EPT/Ceramic 4949 AE5/AS5



8.12 PARTS LIST - LX INSTRUMENT

Note: Typical parts list shown. Please supply model and serial numbers when ordering parts

PART #	DESCRIPTION
299082	Bracket, home switch SI MD-1642
781000	Caster 2" swivel #EY459R
1835050	Contactora #3030APS 30 AMP
1843601	Adapter coupling SI MD-1642
2735358	Sentra top SS - DWG #EP-103
2746237	Electrical enclosure door SS - DWG #EP-103
2761201	Electrical sub panel - DWG #EP-103
2851112	Gauge panel - DWG #EP-103
2877542	Base - DWG #EP-103
3581000	Pressure gauge 0-160 PSI 2" face
3708505	Plastic handle P2-41
3775510	Heater 10KW 2/4/3/60 square flange
3520005	Heater flange gasket 4.50" OD
4439900	Instrument kit SK-SI
4713377	Drip Cover SI MD-1642
6207000	Motor/pump assembly AS5 3/4HP ODP 230/460
414	Adapter iron C2-4551 AS5
771599	Pump case iron 137-001-166 AS5
3444400	Tank gasket 2-3/8" A-9159 AS5
3444401	Gasket, tank flange 4-1/2" AS5
4310602	Impeller B2-5264 4.5" AS5
4310611	Impeller AS5 #100345 4.5" mfg. After 2-97
4714466	Motor 3/4HP 113-000-354T 2/4/3/60
4757862	Motor AE5/AS5/A5W 3/4HP #S-2772R
5486522	Nut S-4989 AS5
5622271	O-ring case 116.000.252
6490000	Shaft seal niresist 5/8"
6491000	Shaft seal ceramic 5/8"
6748201	Cap screw #102RO3A2
9118502	Impeller washer #100301
7370000	Motor starter CR354AB3AA1B
1733456	Auxiliary contact kit #353XAAA
7541000	Panel mount pressure switch #82681
7732250	Heater cylinder AS5 #D2-1841
8240000	Transformer 9T58B42
8764940	AVT valve SI 1/2"
8764939	AVT SI repair kit #EH-124
8764949	AVT drive kit for 3/8" and 1/2" valves #977700
9060000	Pressure relief valve #150 PSI



THIS PAGE INTENTIONALLY BLANK

END

© 2013 TEMTPEK, INC.

RE 1 20/13

